



Liebert® S600D,3x1,10-20kVA

User Manual

S600D,3x1,10-20kVA

UNINTERRUPTIBLE POWER SUPPLY

USER MANUAL

504902039028– rev. 0

All rights, including rights of translation, reproduction in any form or other usage of this document, or any part of it, are reserved.

Transgressors will be liable for damages.

All rights, including rights deriving from the granting of patent or registration of utility, model or design, are reserved.

Delivery subject to availability. The Manufacturer reserves the right to make changes and/or improvements to the product without prior notice and without incurring obligations.

S600D may differ from the model displayed on the front cover.

Special Declaration

Safety of Personnel

1. This product must be installed by qualified professionals, engineers appointed by the manufacturer or an authorized agent. Failure to observe this condition may result in product malfunction, and compromise the safety of personnel.
2. Take the time to read this product manual and the safety precautions thoroughly before installing and commissioning this product. Failure to observe this condition may result in product malfunction, and compromise the safety of personnel.
3. This product is not intended for use with life support systems
4. Never attempt to dispose of the internal and external batteries in fire as they may explode, leading to serious injuries, or even death.

Product Safety

1. If the product is to be stored or unused for extended periods, place the equipment in a clean, dry environment within the specified temperature range
2. This product should be used in an appropriate operating environment. Consult the Site Preparation section for information about the ideal operating and maintenance environment for this product
3. This product is not designed for use in conditions and/or environments where:
 - The temperature and relative humidity are outside the specified limits
 - It is subject to vibration or shocks
 - It is exposed to the presence of conductive dust, corrosive gases, salts, or inflammable gases
 - It is exposed to heat sources or strong electro-magnetic interference

Disclaimer

VERTIV may not be held accountable or responsible for defects and malfunctions arising for the following reasons:

- Application range or operating environment outside the specified limits
- Unauthorized modification, incorrect installation or operation
- Force majeure
- Other actions not in compliance with the instructions in this manual

Safety Precautions

Always observe the following safety symbols!



Warning

Used to alert the user to the risk of death or severe injury should the unit be used improperly.



Note Caution

Used to alert the user to the risk of injury or damage to the equipment should the unit be used improperly.



Important

Used for instructions that the user must read carefully and observe, even if failure to do so may not result in damage.

This manual contains information concerning the installation and operation of single UPS modules and parallel systems of the Vertiv S600D 10kVA-20kVA UPS.

Read this manual thoroughly before installing, using and servicing the UPS.



Warning

This UPS has been designed for use in commercial and industrial environments. Installation restrictions or additional measures may be required to prevent disturbances.



Conformity and standards

This product complies with the Directives 2014/35/EU (low voltage safety) and 2014/30/EU (EMC), and the following UPS product standards:

* IEC/EN62040-1+A1:2013 General safety requirements for UPS

* IEC/EN62040-2:2006 EMC

* IEC/EN62040-3 Performance requirements and test methods

For more details, refer to Chapter 10 .

Continued compliance requires installation in accordance with these instructions and the use of manufacturer approved accessories only.



Warning: high earth leakage current

The unit must be connected to earth before it is connected to its AC mains input and battery power supplies. This equipment is fitted with an EMC filter.

The earth leakage current ranges from 0 to 1000 mA.

Transient and steady state earth leakage currents, which may occur when the equipment is started, should be taken into account when selecting the instantaneous RCCB or RCD devices.

RCCB devices that are sensitive to unidirectional DC pulses (Class A) and immune to transient state current pulses must be selected.

It is also necessary to take into account that the load earth leakage currents will be borne by the RCCB or RCD.

The equipment must be earthed in compliance with the local electrical code of practice.



Warning

When selecting the UPS system upstream distribution protection devices, ensure that comply with the specifications indicated in 3.1.4 , and with the local electrical regulations.



Warning: backfeed protection

This UPS is fitted with a dry contact for use with an external automatic disconnecting device (not supplied) in order to prevent the UPS voltage from being fed back to the input terminals through the rectifier or bypass static switch circuit. A label must be placed on or near the all external primary input supply disconnecting devices to warn service personnel that the circuit is connected to a UPS. The text of the label must have the following meaning: Risk of voltage backfeed! Isolate the UPS, then check for hazardous voltages between all terminals, including the protective earth, before working on this circuit.



General safety precautions (For users)

Like other types of large power equipment, the UPS and battery circuit breaker box/battery cabinet contain high voltages. This equipment meets the IP20 standard, and other safety panels are fitted inside the equipment. The UPS may be operated in complete safety, provided the general instructions and the steps recommended in this manual are followed.



Multiple power inputs (For users)

This UPS system receives power from more than one source. All DC and AC power sources must be disconnected before servicing. This UPS includes several circuits that are energized by high AC as well as DC voltages. Check for voltage with both AC and DC voltmeters before working inside the UPS.



User serviceable components (For service personnel)

All equipment maintenance and servicing procedures involving internal access require the use of a tool and should be carried out by trained personnel only. There are no user-serviceable parts behind the covers that require a /key for removal.



Battery voltage: 320Vdc - 540Vdc (For service personnel)

All battery maintenance and servicing procedures require the use of tools and should be carried out by trained personnel only. Take special care when working with the batteries associated with this UPS. When connected together, the battery terminal voltage will exceed 320Vdc and is potentially lethal. Battery manufacturers supply details of the necessary precautions to be observed when working on, or in the vicinity of, a large bank of battery cells. These precautions should be followed scrupulously at all times. Special attention should be paid to the recommendations concerning local environmental conditions and the provision of protective clothing, first aid and fire-fighting facilities.



Warning

When the internal fuse of the UPS is damaged, it must be replaced with fuse having the same electric parameters by qualified personnel.



Important

The area housing the communication board contains static sensitive components, therefore it is necessary to adopt all the appropriate ESD-proof measures before accessing this area.



Warning

In order to satisfy the conditional short circuit current rating, Icc at 10kA symmetrical rms, the specified upstream breakers must comply with an IEC 60947 series standard.



Warning

The UPS is unable to automatically isolate the neutral connection, ensure to have 4P breaker upstream and downstream the UPS in case of IT distribution.

This Manual describes the following devices

Product	Model
Liebert S600D 10kVA (Standard UPS)	
Liebert S600D 20kVA (Standard UPS)	

Contents

Chapter 1 Overview	9
1.1 Features	9
1.2 Design Concept	9
1.3 Parallel System	12
1.4 Operating Modes	13
1.5 Battery Management	15
1.6 Battery Protection	16
Chapter 2 Mechanical Installation	17
2.1 Precautions	17
2.2 Transportation	17
2.3 Tools	18
2.4 Unpacking	19
2.5 Initial Inspection	21
2.6 Environmental Requirements	21
2.7 Mechanical Requirements	22
2.8 Installation Drawings	23
Chapter 3 Electrical Installation	25
3.1 Connecting the Power Cables	25
3.2 Wiring the Signal Cables	31
Chapter 4 Operator Control and Display Panel	35
4.1 Introduction	35
4.2 LCD Menu Structure	40
4.3 LCD Screen Types	40
4.4 Prompt Window	46
4.5 UPS Alarm Message List	46
Chapter 5 Operating Procedures	50
5.1 Brief Introduction	50
5.2 UPS Start-up Procedures	51
5.3 Procedures for Transferring Between Operating Modes	54
5.4 UPS Shut-down Procedures	58
5.5 REPO	58
5.6 Automatic Restart	59
5.7 Language Selection	59
5.8 Changing the Current Date And Time	60
5.9 Setting the Password	61
Chapter 6 Battery	65
6.1 Introduction	65
6.2 Safety	65
6.3 UPS Battery	67
6.4 Precautions For Installation Design	68
6.5 Battery Installation Environment and Number of Batteries	68
6.6 Battery Protection	69

6.7 Battery Installation and Connections	69
6.8 Designing the Battery Room	70
6.9 Battery Maintenance	70
6.10 Disconnecting or Connecting Internal Battery Terminals	71
6.11 Disposal of Used Batteries	72
Chapter 7 Parallel System and LBS System.....	73
7.1 General	73
7.2 System Installation Procedures	73
7.3 Operating Procedures for Parallel Systems.....	75
7.4 LBS System.....	78
Chapter 8 Options	82
8.1 List of Options	82
8.2 Option Introduction	82
8.3	
Chapter 9 Service And Maintenance	92
9.1 Fan Maintenance	92
9.2 Battery Maintenance.....	92
9.3 Cleaning the UPS	93
9.4 Checking the UPS Status.....	93
9.5 Checking the UPS Functions	93
Chapter 10 Specifications.....	94
10.1 Conformity and standards	94
10.2 Environmental Characteristics	94
10.3 Mechanical Specifications	94
10.4 Electrical Specifications (Input Rectifier)	95
10.5 Electrical Specifications (Intermediate DC Circuit)	95
10.6 Electrical Specifications (Inverter Output)	96
10.7 Electrical Specifications (Bypass Input).....	96
Appendix 1 LCD Parameter Settings	97
Appendix 2 Glossary.....	99
Appendix 3 Hazardous Substances And Content.....	100

Chapter 1 Overview

This section provides a short introduction to the Liebert S600D 10kVA - 20kVA UPS (hereafter referred to as “the UPS”), covering features, design concept, parallel system, operating mode, battery management and battery protection.

1.1 Features

The UPS is connected between a critical load (e.g. a computer) and the mains power supply to provide high quality power for the loads. The UPS provides the following advantages:

- Increased power quality

The UPS protects its output against the variations in the input power supply by means of the intelligent controller.

- Improved noise rejection

Due to the use of AC-DC-AC conversion, noise on the input power supply is effectively filtered, so that the load is provided with a “clean” power supply.

- Mains failure protection

If the input power fails, the UPS switches to battery operating mode so that the power supply to the loads is not interrupted.

- Compatible with two output modes

3-in 3-out (factory default) and 3-in 1-out (by installing an optional 3-in 1-out copper bar kit). Only authorized personnel are permitted to change the wiring method and modify the corresponding parameters using the VERTIV setting software.

1.2 Design Concept

1.2.1 System Design

This section introduces the working principle of the single UPS module. The UPS adopts AC-DC-AC conversion (as shown in Figure 1-1). The first stage conversion (AC-DC) uses a three-phase, high frequency rectifier to convert the three-phase input voltage into a stable DC bus voltage.

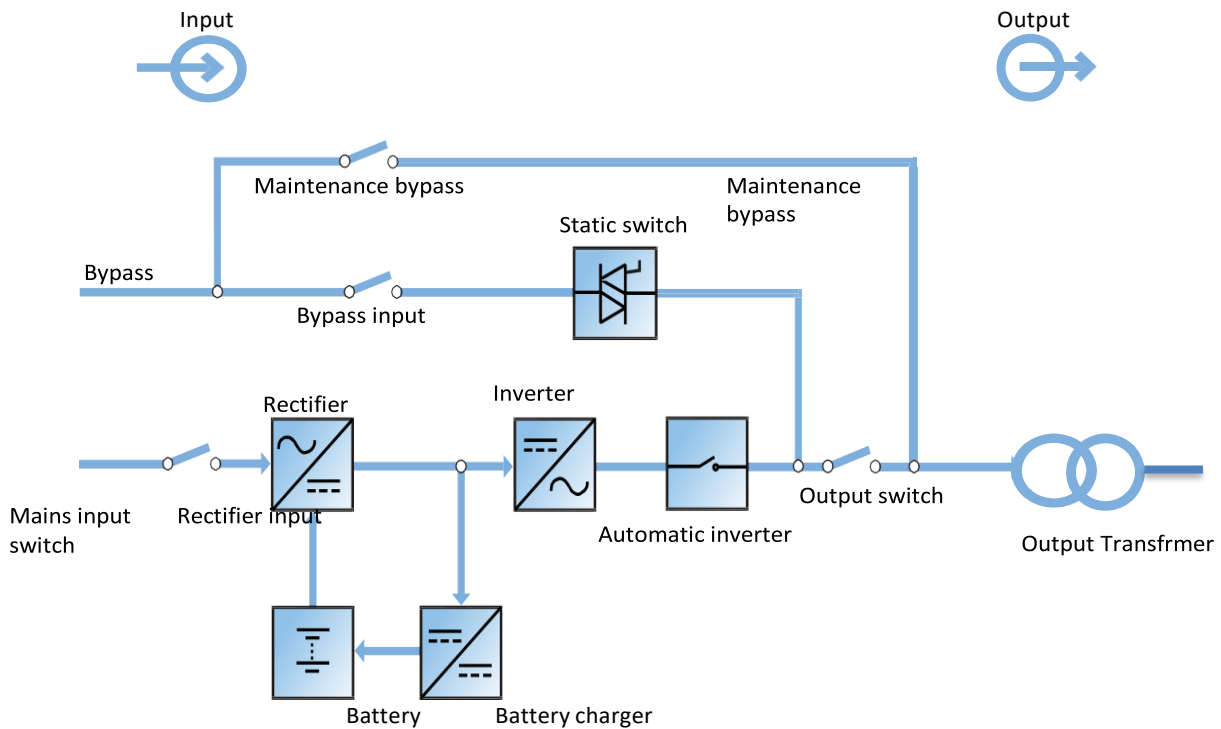

Figure 1-1 Block diagram illustrating the working principle of a UPS single module

The UPS has its own battery charger and adopts advanced temperature compensation technology to effectively prolong the battery service life. The inverter is principally based on the use of large power IGBTs, and adopts advanced SVPWM control technology to reconvert the DC bus voltage to AC voltage.

When the mains is normal, the rectifier and inverter work together to supply the loads and charge the battery.

When the mains is outside normal limits, the rectifier stops working, and the battery supplies power to the loads through the inverter. If the battery voltage falls to end of discharge (EOD) voltage and the mains has not yet returned within the normal limits, the UPS will shut down (if the system uses split bypass configuration and the bypass is normal, the system will transfer to bypass). The battery EOD voltage is pre-set. When the mains is abnormal, the battery will continue to supply the UPS until the battery voltage reaches to EOD level, whereupon the UPS shuts down; this period is known as the 'Backup Time'. The duration of the backup time depends on the battery capacity and the loads.

1.2.2 Bypass

Thanks to the intelligent control function provided by the 'Static Switch' module (as shown in Figure 1-1), which includes the controllable electronic switch, the loads may be supplied either by the inverter or the bypass. Under normal operating conditions, the loads are supplied by the inverter, in which case the automatic inverter switch on the inverter side is closed. In the event of an overload (after the overload delay period has elapsed) or inverter failure, the inverter switch is opened, and the 'Static Switch' module transfers the loads automatically to the bypass. In normal operating state, in order to guarantee the uninterrupted transfer between inverter and bypass, the inverter output must be synchronized with the bypass.

Therefore, when the bypass frequency is within the synchronization range, the inverter control circuit will synchronize the inverter output frequency with the bypass frequency and phase.

The UPS is also equipped with a manual maintenance bypass switch that can be used to shut the UPS down during maintenance. In this condition, the bypass will supply the critical loads directly via the maintenance bypass.



Note

When the load is supplied by the bypass or maintenance bypass, the power quality & availability will be unregulated.

1.2.3 System Control Principle

Normal operation

Normal mode: In this condition, the UPS mains input supply is within normal limits, the rectifier and inverter operate normally, the load is supplied by the inverter, the battery circuit breaker is closed, and the battery is in the stable floating charge state.

(Parallel System) Note: As the individual UPS module outputs are connected in parallel, the system checks that the inverter control circuits are perfectly synchronized with one another and with the bypass in terms of both frequency and phase, and that the output voltages are the same. The current supplied to the load is automatically divided among the UPS units. A warning message appears while synchronization is in progress.

Mains abnormal

When the mains fails or is abnormal, the rectifier will stop working automatically, and the system will transfer to battery output (through the inverter). The length of the operation time in battery mode depends on the load and the battery capacity. During this period, if the battery voltage falls to the EOD level before the mains supply has returned within normal limits, the inverter will stop working automatically, and the UPS operator control and display panel will display the corresponding alarm messages. If the system uses split bypass configuration and the bypass is normal, the system will transfer to bypass.

Mains recovery

When the mains returns within normal limits within the permissible time, the rectifier will start automatically (at this point its output power will increase gradually) and supply the load and charge the battery again. This means that the power supply to the load will not be interrupted.

Disconnecting the battery

To disconnect the external battery from the UPS system during maintenance, use the external isolation device. In this condition, the battery backup function will not be available in the event of a mains failure, but none of the other UPS functions and performance will be affected.

UPS module failure

In the event of an inverter failure, automatic inverter switch failure, or if the output fuse blows, the load will automatically transfer to the bypass, and the output power supply will not be interrupted. Should this condition occur, please contact your local VERTIV customer service centre for technical support.

(Parallel System) In the event of a fault on a UPS module, it will automatically exit the parallel system. If the system is still capable of providing the power required by the load, the remaining modules will continue to supply the load without interruptions. If the remaining modules are no longer capable of fulfilling the power requirements, the load will automatically transfer to the bypass.

Overload

If the inverter is overloaded or the inverter current remains outside the specifications (refer to Table 10-6) longer than the specified time, the load will automatically transfer to the bypass without any interruption in the power supply to the load. If both the overload and the current are reduced to a level within the specified range, then the load will be re-transferred to the inverter. In the event of an output short circuit, the load will be transferred to the bypass, and the inverter will shut down. The transfer is determined primarily by the characteristics of the system protection device.

In both the situations listed above, the UPS operator control and display panel will display the corresponding alarm messages.

(Parallel System) The control logic system constantly monitors load requirements and controls the power supplied by each UPS module. If an overload condition persists for longer than a pre-set period and the number of active modules is unable to satisfy load requirements, the load will transfer to the bypass. The load is re-transferred to the inverter if the power is reduced to a value that can be sustained by the number of active modules in the system.

Maintenance bypass

The UPS is equipped with a second bypass circuit, known as the maintenance bypass, which provides a safe working environment for the engineers to carry out regular maintenance or repair the UPS system, while providing unregulated mains supply to the loads. The maintenance bypass can be activated manually selected by closing the maintenance bypass switch, and disconnected by setting the switch to OFF.



Warning

If the UPS system consists of two or more UPS modules, and the load capacity exceeds the single module capacity, do not use the internal maintenance bypass switch.

1.2.4 UPS Power Supply Switch Configuration

Figure 1-2 illustrates the block diagram of the UPS module. The UPS may be connected in split bypass (where the bypass is supplied by a separate mains input source) or common input configuration. In the split bypass configuration, the static bypass and maintenance bypass share the same independent bypass power supply. Where a separate power source is not available, the input supply connections of the bypass input switch (Q2) and rectifier input switch (Q1) should be linked together (these terminals are linked before delivery) so that the bypass input and rectifier input use mains power from the same source.

During the normal UPS operation, all switches should be closed, with the exception of the maintenance bypass switch Q3.

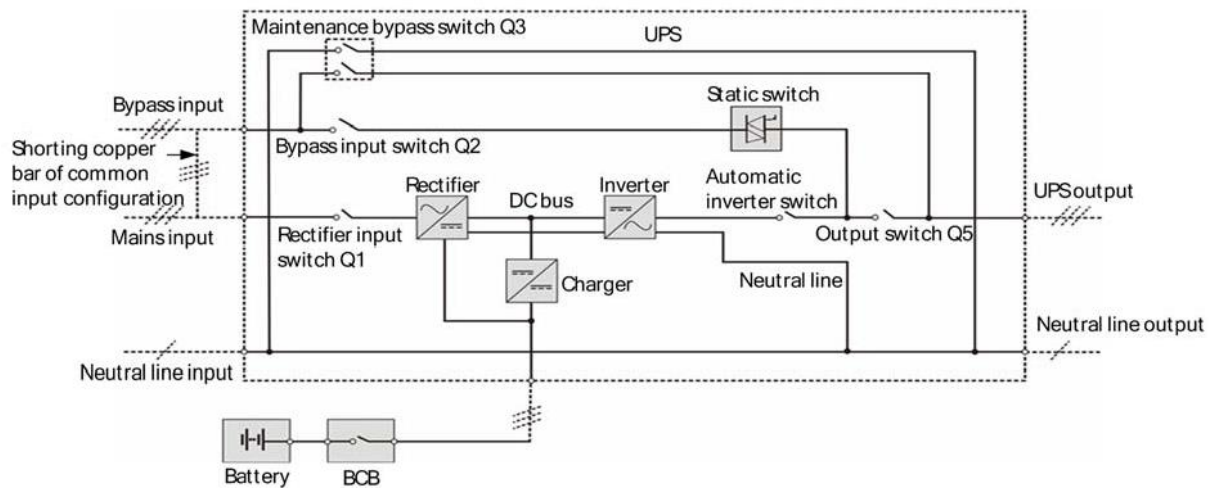

Figure 1-2 UPS power supply switch configuration

1.2.5 Battery Circuit Breaker (BCB)

The external battery shall be connected to the UPS via the BCB. The BCB box is an option that must be installed close to the battery.

1.3 Parallel System

Up to four UPS modules may be parallel-connected to form a parallel system and increase the system capacity and reliability. The load is shared equally between the parallel connected UPS modules.

Also, two UPS modules or parallel system may be used to form a dual bus system (LBS). Each UPS module or parallel system has an independent output. Output synchronization is achieved through the LBS cable, thus enabling seamless load transfer between the two systems.

1.3.1 Parallel System Features

1. The hardware and software of a parallel system are identical to those of the individual modules. The parallel system is configured by modifying the respective settings in the configuration software or via the control panel.
2. Parallel cables are connected in a ring, providing both system reliability and redundancy. LBS cables are connected between any two UPS modules of each bus. The intelligent parallel logic provides the user with maximum flexibility. For example, the UPS modules in a parallel system can be shut down or started up in any order. Transfers between normal mode and bypass mode of operation are seamless and self-recoverable, i.e, when the overload is cleared the system will revert automatically to its original operating mode.
3. The total load of the parallel system can be queried from the LCD screen on each UPS module.

1.3.2 Parallel System Requirements

A group of paralleled modules behave as if it were one large UPS with the advantage of providing increased reliability. To ensure that all modules are utilised equally and to comply with relevant wiring rules, the following requirements apply:

1. All UPS modules must be of the same rating and must be connected to the same bypass source.
2. The bypass and rectifier input sources must be connected to the same neutral line input terminal.
3. If any RCD devices are installed they must be set-up appropriately and located upstream of the common neutral line input terminal. Alternatively, the device must monitor the protective earth current of the system. Refer to *Warning: high earth leakage current* before *Contents*.

1.4 Operating Modes

Operating Principle

The operating principle of the UPS is shown in the figure 1-4.

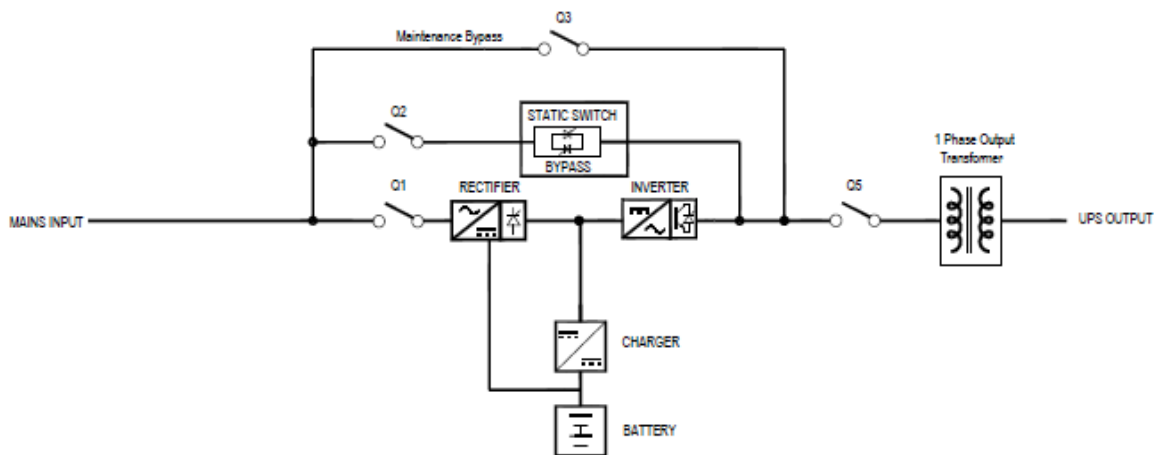

Figure 1.4 (3X1 UPS with Output Transformer)

1. The UPS is composed of mains input (main and bypass), rectifier/PFC, charger, inverter, bypass, battery, DSP controller, isolation transformer, contactor and final output.
2. When the mains is normal, the rectifier will start, and the charger will charge the battery string. Before turning on the UPS, the output voltage is bypass voltage, and the mains supplies power to the load through the bypass. After turning on the UPS, the electronic transfer switch connects the inverter output to the load, and the mains supplies DC power to the inverter through the rectifier/PFC circuit. The inverter then converts DC power into pure sine wave AC power and supplies the AC power to the load through electronic transfer switch. Isolation Transformer is connected at the output side for 3X1, Refer figure 1.4 for the position of Output Isolation Transformer. Output is fed to Load through Contactor because of Transformer at Output side.

The UPS features the following operating modes:

- Normal mode
- Battery mode
- Bypass mode
- Maintenance mode
- ECO mode
- Parallel redundancy mode (system expansion)
- LBS system mode
- Common battery string mode

Normal mode

As shown in Figure 1-3, the mains is rectified by the UPS rectifier and then inverted by the inverter to supply uninterrupted AC power to the loads. At the same time, the charger will charge the battery.

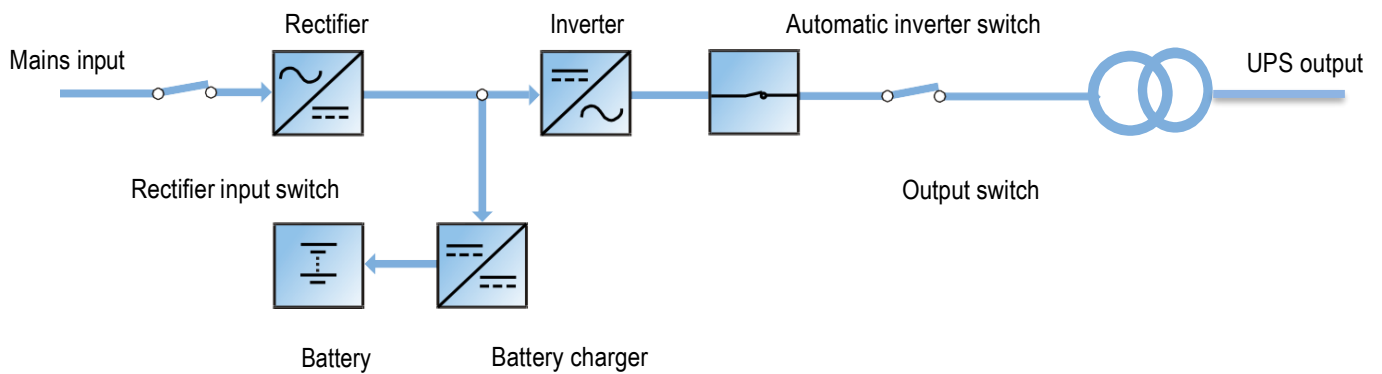

Figure 1-3 Normal operating mode line diagram

Battery mode

As shown in Figure 1-4, the operating mode where the battery provides the backup power supply to the loads through the rectifier and inverter is called battery mode. In the event of a mains failure, the system will transfer automatically to battery mode with no interruption in the power supply to the load. When the mains power supply is restored, the system will re-transfer automatically to normal operating mode without any manual intervention, and with no interruption in the power supply to the load.

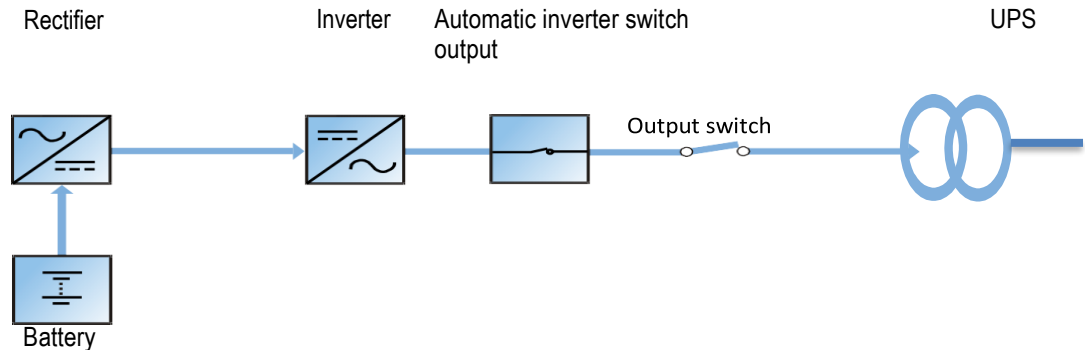

Figure 1-4 Battery operating mode line diagram



Note

The battery cold start function may be used to switch the UPS on in Battery (charged) mode directly during mains failure. This means that the battery power supply can be used independently to improve the availability of the UPS.

Bypass mode

As shown in Figure 1-5, in normal mode, in the event of an inverter failure, inverter overload or inverter manual shut down, the static switch will transfer the load from the inverter side to bypass side, with no interruption in the power supply to the load. In this case, if the inverter and bypass are not synchronized, there will be a transitory interruption in the power supply to the load (not exceeding 20ms).

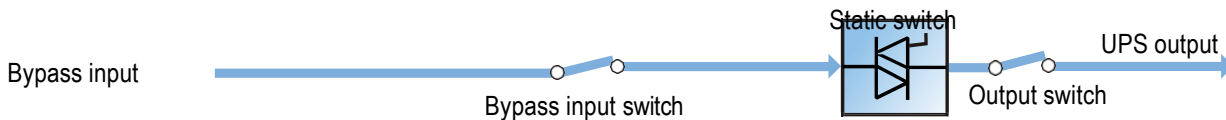

Figure 1-5 Bypass operating mode line diagram

Maintenance mode

As shown in Figure 1-6, if it is necessary to service the UPS or carry out maintenance work on it, you may use the manual maintenance bypass switch to transfer the load to maintenance bypass, with no interruption in the power supply to the load. This maintenance bypass switch is fitted in all UPS modules and rated for full load of one module.

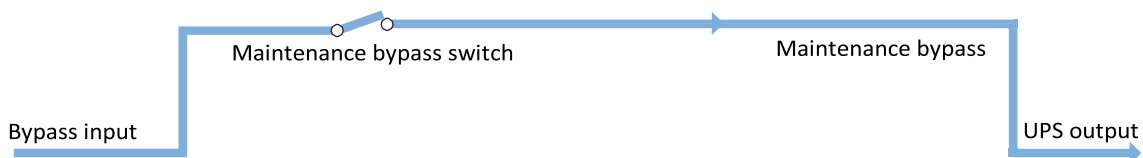

Figure 1-6 Maintenance operating mode line diagram

ECO mode

If ECO mode is selected, all the power switches and the BCB are closed, and the system selects the bypass as the preferred source of power for the load, in order to save energy. When the bypass supply frequency and voltage are within normal limits (adjustable), the load is powered by the bypass, with the inverter on stand-by; when the bypass voltage and/or frequency is outside these pre-defined and adjustable limits, the system will transfer to the inverter output. In this mode, the system can charge the battery normally.

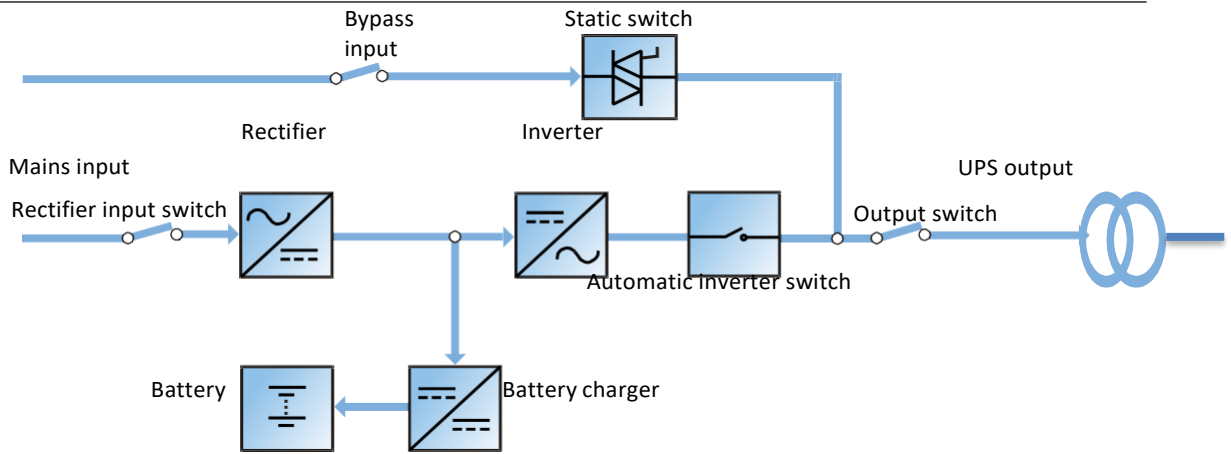

Figure 1-7 ECO operating mode line diagram



Warning

The load is not protected against distortion on the mains voltage waveform in ECO mode.

Parallel redundancy mode (system expansion)

For higher capacity or higher reliability, or both, the outputs of multiple UPS modules can be programmed for directly paralleling while a built-in parallel controller in each UPS module ensures automatic load sharing. The parallel system may consist of up to four UPS modules. For the operating principle diagram of parallel redundancy mode, see Figure 7-1.

LBS mode

A dual bus system consists of two independent UPS systems, each containing one or more parallel UPS modules. The dual bus system provides high reliability, which makes it suitable for use with loads having multiple input terminals. In the case of single-input loads, an STS may be installed to power the load. For the operating principle diagram of LBS mode, see Figure 7-4.

Common battery string mode

In this mode, when the UPS modules (up to four UPS units) are connected in parallel, they share the same battery string thus providing cost and space savings.



Note

Never use batteries having different brands, type or capacities in the same system. Common battery string mode is suitable for parallel systems only, and is not compatible with LBS mode.

1.5 Battery Management

The following battery management functions are set by the service engineer using the VERTIV setting software.

1.5.1 Normal Function

1. Constant current boost charge

Uses a constant current (within battery charging limit) to charge the battery. This function can be used for fast battery capacity recovery. It is possible to modify the value of the charge current.

2. Constant voltage boost charge

Uses a constant voltage to charge the battery. This function can be used for fast battery capacity recovery. In the case of VRLA batteries, the maximum boost charge voltage should not exceed 2.4V/cell.

3. Float charge

This charging method is used for maintaining the battery at full capacity. The float charge voltage is generally low. This function can be used to compensate for capacity loss due to battery self-discharging, and to recover battery capacity.

In the case of VRLA batteries, the float charge voltage should be between 2.2V/cell and 2.3V/cell.

4. Automatic transfer to floatcharge

When the charge current is less than the 'Threshold of Equalize Charge to Float Charge' value, the charger will automatically transfer from boost charge to float charge. When the boost charge time exceeds the 'Equalize Charge Protect Time Limit', the charger will be forcibly transferred to float charge in order to protect the battery.

5. Float charge temperature compensation (optional)

This function must be used together with the battery temperature detection device. The VERTIV battery temperature sensor is a standard option designed to satisfy your requirements.

6. EOD protection

When the battery voltage falls to the EOD level, the the battery converter shuts down automatically and the battery is disconnected in order to avoid further battery discharge. The EOD voltage may be set to between 1.6V/cell and 1.85V/cell (VRLA).

7. Battery low pre-warning time

The battery low pre-warning time may be set to between 2min and 30min. The default setting is 2min.

8. Maximum battery discharge time

When the battery is discharged at low current levels for extended periods, it will result in excessive discharge and may even cause irreparable damage, for this reason it is essential to set-up a maximum battery discharge time in order to protect it. This limit value is set-up by the service engineer using the VERTIV setting software.

9. Maximum boost charge protection time

To protect against the battery overcharge damage caused by long time boost charge, it is essential to set-up a protection time a protect time limit This limit value is set-up by the service engineer using the VERTIV setting software.

1.5.2 Battery Temperature Compensation

The UPS system also features a battery charge temperature compensation function. When the ambient temperature is increased, the DC bus voltage (which charges the battery) will be reduced correspondingly to provide optimal charging voltage for the battery, thus prolonging the battery service life time. This function must be used together with the VERTIV battery temperature detection device (standard option).

1.6 Battery Protection

The following battery protection functions are set by the service engineer using the VERTIV setting software.

Battery low pre-warning

The battery low pre-warning occurs before the EOD. The time can be set to between 2min and 30min.

EOD protection

When the battery voltage falls to the EOD level, the battery converter shuts down automatically. The EOD voltage may be set to between 1.6V/cell and 1.85V/cell (VRLA).

Chapter 2 Mechanical Installation

This section provides a brief introduction to the UPS mechanical installation procedures, including the precautions, initial inspection before installation, environmental requirement, mechanical requirement and installation diagram.

2.1 Precautions

This section describes the environmental and mechanical requirements and mechanical considerations that must be taken into account when planning the positioning and cabling of the UPS equipment.

Because no two sites are the same, this section does not provide the detailed installation procedures, and is only intended to act as a guide for the general procedures and practices that should be carried out by the installing engineer, so that they can handle the specific situation at the site correctly.



Warning: professional installation required

1. Do not dismantle the packaging without the permission of an authorised service engineer.
2. The UPS should be installed by an authorised engineer in accordance with the information provided in this section.



Warning: battery danger

Take special care when installing batteries. When connecting batteries, the battery terminal voltage will reach 320Vdc, which is fatal to human beings.

1. Always wear safety glasses to protect the eyes from being damaged by arcing.
2. Remove all the metal items, including finger rings, watch, etc.
3. Use tools with insulated handles.
4. Wear rubber gloves.
5. If batteries are damaged or leak electrolyte they must be replaced. Place the battery into the container that can withstand sulphuric acid and dispose of it according to the local regulations.
6. In the event of contact with electrolyte, wash the affected are with abundant clean water immediately.

2.2 Transportation

Rail and sea shipping are the recommended transportation methods. If road transportation is unavoidable, choose roads that are less bumpy in order to protect the equipment.

The UPS cabinet is heavy (see Table 10-3 for the weight). We recommend using mechanical equipment such as an electric forklift to unload and move the equipment to the place closest to the installation site.

2.3 Tools



Warning

1. For reasons of safety, all installation tools used on live components must be insulated.
2. The tools listed in Table 2-1 are for reference only; please adapt to the actual requirements for on-site installation and connection.

Table 2-1 Tools

Name	Drawing	Name	Drawing
Electric hand drill		Adjustable wrench	
Slotted screwdriver		Cross head screwdriver	
Stepladder		Forklift	
Drill		Wire cutting pliers	
Claw hammer		Diagonal cutting pliers	
Insulating shoes		Antistatic gloves	
Electrician's knife		Cable ties	
Insulating tape		Insulating gloves	
Crimping pliers		Heat shrinkable tube	
Insulated torque wrench		Torque screwdriver	
Multimeter		Clip-on ammeter	

2.4 Unpacking

Unpack the UPS and battery packages under the supervision of an authorized service engineer.

Proceed as follows:

1. Remove the carton.

Remove the packing strap and lift the whole carton upwards, as shown in Figure 2-1.

Removing carton from standard UPS

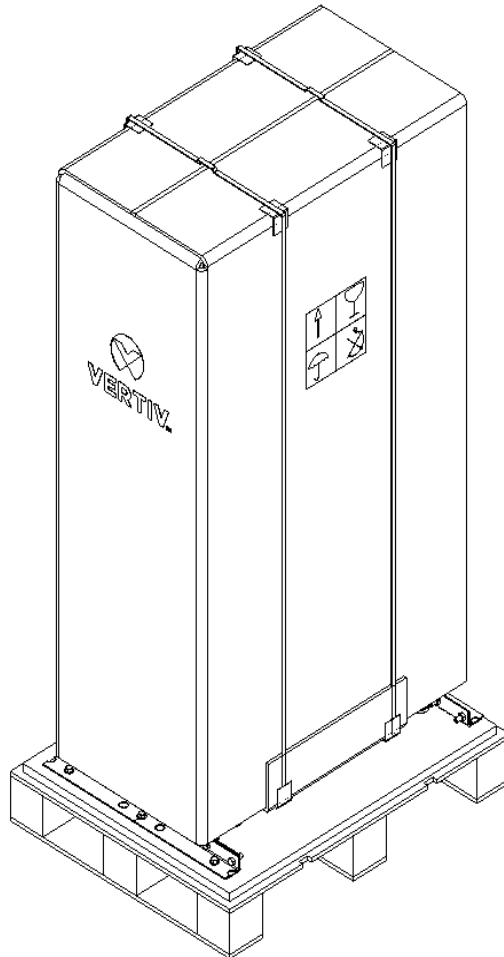

Figure 2-1 Removing cartons

2. Remove the fixing structural parts from the bottom pallet (see Figure 2-2), do not throw them away. Next, use the forklift (inserting the forks at the points illustrated in Figure 2-2) to move the cabinet close the installation site.

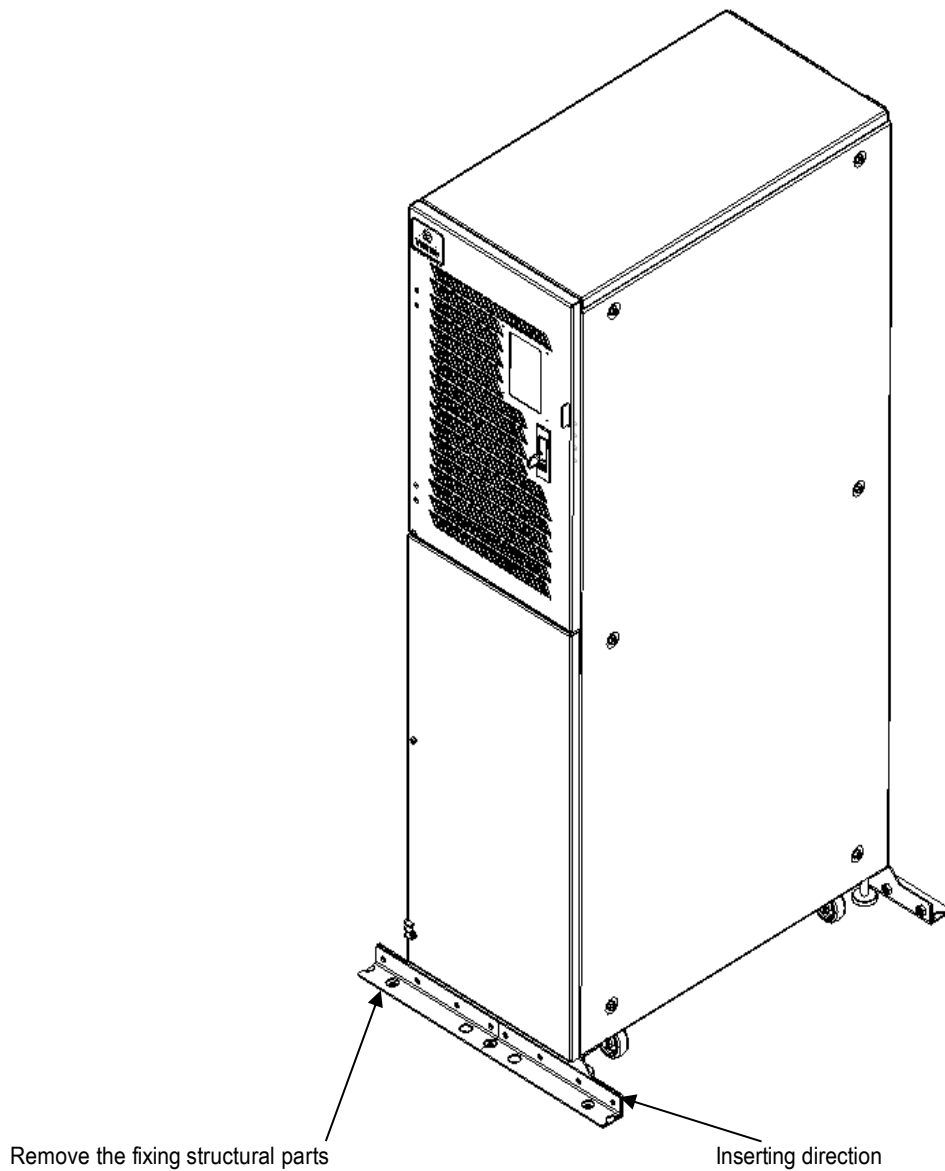

Figure 2-2 Removing the bottom pallet

3. After moving the cabinet to the installation site, you raise the adjustable feet and use the castors to move the cabinet to its final installation position, finally, rotate the adjustable feet until they are in contact with the floor. See Figure 2-3 for the finished installation.



Note

1. It is not necessary to install the fastening structural parts of the bottom pallet in the case of UPS with side cabinet

2. In the case of UPS , simply secure the fastening structural parts removed in step 2 to the cabinet bottom (See right drawing); in the case of UPS , install the fastening structure parts to both the left and right hand sides (See left drawing) based on the right drawing to avoid tipping.

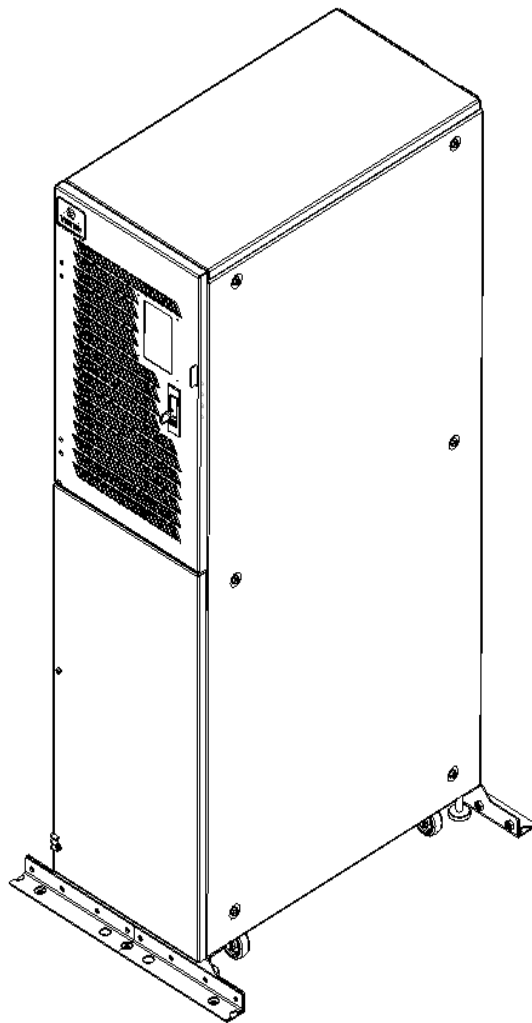

Figure 2-3 Completed installation

2.5 Initial Inspection

Before installing the UPS, carry out the following inspections:

1. Ensure that the UPS equipment room meets the environmental requirements specified in the product technical specifications, especially the ambient temperature, ventilation conditions, and the levels of dust.
2. Unpack the UPS and battery under the supervision of an authorized service engineer. Visually inspect the inside and outside of the UPS and battery for any shipping damage. If there is any damage, report it to the carrier immediately.
3. Verify the UPS label and confirm that the UPS model conforms to the information indicated on it. The UPS label is attached to the rear of the door. The UPS model, capacity and the main parameters are marked on the label.

2.6 Environmental Requirements

2.6.1 Selecting the UPS Location

The UPS should be located in a cool, dry, clean-air indoor environment with adequate ventilation, and should be located on concrete or other non-flammable, flat surfaces. The surrounding environment should be free from conductive powders (such as metallic powder, sulphide, sulphur dioxide, graphite, carbon fibre, conductive fibre, etc.), acid mist or other conductive media (strongly ionized substances). The environmental specifications should comply with relevant international standard & specifications and the operating range (see Table 10-2) specified in this manual.

The UPS uses forced cooling by internal fans. Cooling air enters the UPS through the ventilation grills at the front of the cabinet and is expelled through the ventilation grills at the back of the cabinet. Do not obstruct the ventilation holes (ventilation grills). The rear of the UPS should be kept a distance at least 200mm from the wall to avoid blocking the UPS heat dissipation, thus reducing the UPS internal temperature and improving the UPS life.

If necessary, install indoor extractor fans to aid cooling-air flow and avoid temperature build-up in the installation area.



Note

Note 1: When the battery cabinet is installed near the UPS, the maximum allowable ambient temperature is dependent on the battery rather than the UPS.

Note 2: If the UPS is operating in ECO mode, the power consumption will be less than in Normal mode. A proper air conditioning system shall be selected according to the normal operating mode.

2.6.2 Selection the Battery Location

Batteries generate a certain amount of hydrogen and oxygen at the end of the charging cycle, so the fresh air volume of the battery installation environment must meet the EN50272-2001 requirements.

The ambient temperature is the main factor that affects the battery capacity and life. The normal operating temperature of the battery is 20°C. If the ambient temperature is higher than 20°C, the battery life will be reduced. If it is lower than 20°C, the battery capacity will be reduced. Under normal operating conditions, the acceptable ambient temperature for the battery is 15°C to 25°C. The ambient temperature of the battery must be maintained constant, and the battery must be kept away from heat sources and air outlets.

The battery may be installed inside the dedicated battery cabinet, which shall be positioned close to the UPS. If the battery is placed on the raised floor, brackets shall be installed under the floor, just as for the UPS. In the case of rack-mounted batteries or batteries that are installed remotely from the UPS, the battery circuit breaker shall be installed close to the battery, and the cable lengths shall be kept to a minimum.

2.6.3 Storage

Should the UPS not be installed immediately, it must be stored in its original packaging in a location where it is protected against excessive humidity and heat sources (see Table 10-2). The battery must be stored in a dry and cool place with good ventilation. The most suitable storage temperature is between 20°C and 25°C.



Recharge the battery at regular intervals during storage in accordance with the manufacturer's instructions. During the charge process, connect the UPS temporarily to the mains and activate the battery by recharging it.

2.7 Mechanical Requirements

2.7.1 Moving the Cabinet



1. Ensure that the load capacity of the lifting equipment used to move the UPS cabinet is sufficient.
2. The UPS is fitted with castors. When removing the UPS from the shipping pallet, take care to prevent it from sliding. Ensure that sufficient personnel and lifting equipment are available when removing the shipping pallet.
3. Due to the weight of the UPS cabinet, the castors may only be suitable for use on flat surfaces.
4. The centre of gravity of the UPS cabinet is high, take care to prevent it tipping over when moving it
5. The cabinet must never be suspended vertically.



Take special care when moving the battery cabinet with the batteries installed, making sure that each battery string has been secured and keeping movements to a minimum.

Ensure that the UPS weight does not exceed the load capacity of the lifting equipment. For information about the weight of the UPS, refer to Table 10-3.

The UPS may be moved using a forklift truck or similar lifting equipment.

The castors may be used when it is necessary to move it over short distances.

2.7.2 Clearance

Because the UPS is not fitted with lateral grilles, there is no special clearance requirement on either side.

In addition to any local regulations, in order provide sufficient space for routine operations, such as tightening the power terminals inside the UPS, it is recommended that clearance around the front of the UPS should be sufficient to enable free passage of personnel with the door fully open. In addition, it is necessary to leave a clearance of at least 200 mm at the rear of the cabinet in order to permit adequate circulation of the hot air expelled by the UPS.

2.7.3 Cable Access Mode

UPS cable access is from the rear bottom side of the cabinet. For details, refer to 3.1.10 and 3.2.8 .

2.8 Installation Drawings

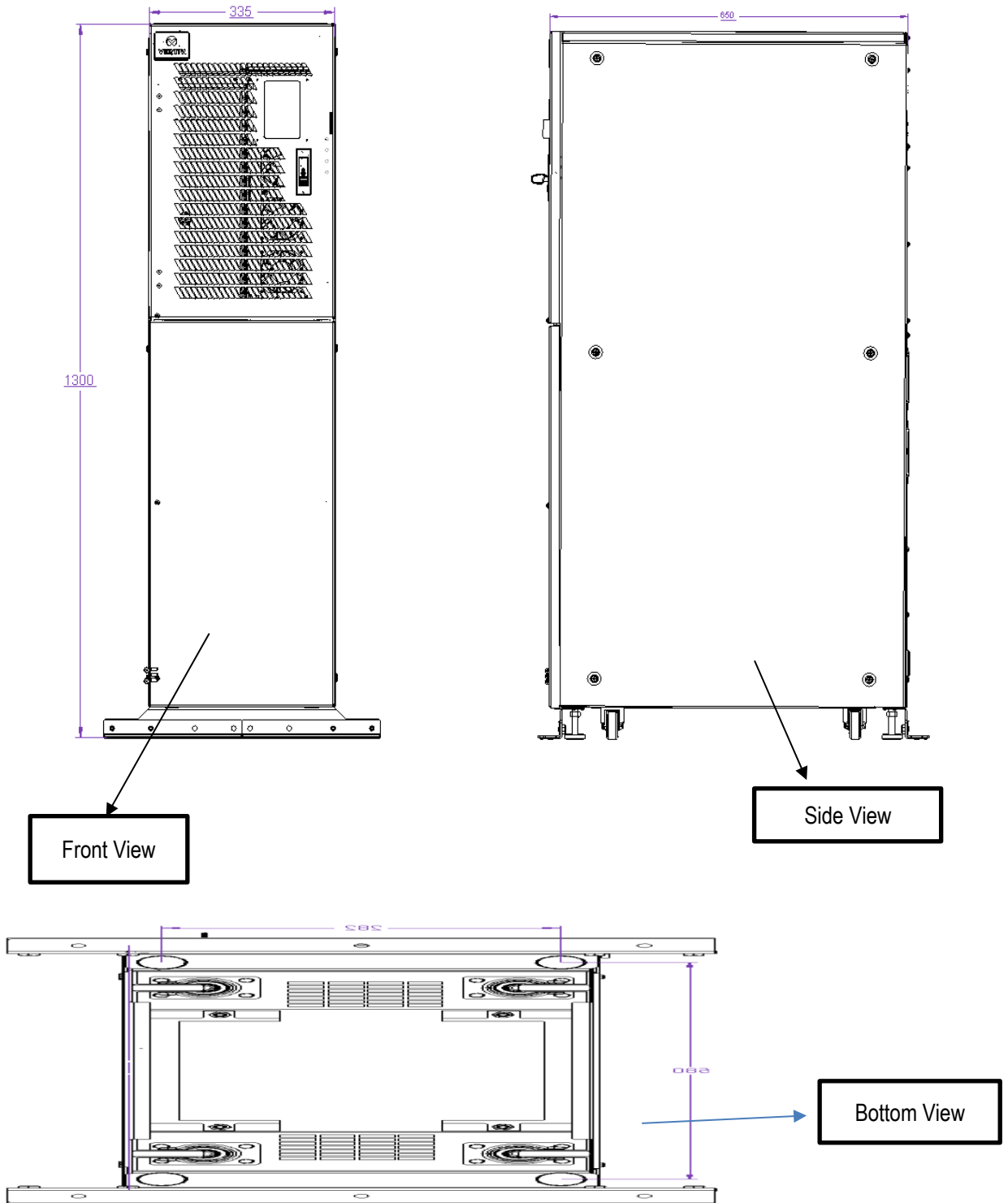

Figure 2-4 Front/side/bottom view of the standard UPS (unit: mm)

Chapter 3 Electrical Installation

This section principally introduces the UPS electrical installation procedures, including the power cable and signal cable connecting procedures and methods.

Once the mechanical installation procedure is complete, it is necessary to connect the power and signal cables to the UPS. All signal cables, whether or not they are shielded, must be kept away from the power cables.



Warning

1. Do not switch the UPS on before the authorised service engineer arrives.
2. The UPS should be routed by an authorised engineer in accordance with the information provided in this section.

3.1 Connecting the Power Cables

3.1.1 System Configuration

The system power cable dimensions shall meet the following requirements:

UPS input cable

The UPS input cable dimension differs depending on the UPS power ratings and input AC voltages, provided that it meets the requirement of maximum input current, including the maximum battery charge current, see Table 3-1.

UPS bypass and output cable

The UPS bypass and output cable size differs depending on the UPS power rating and output AC voltages, provided that it meets the requirement of nominal output or bypass current, as shown in Table 3-1.

Battery cable

Each UPS is connected to the respective battery positive pole, negative pole and neutral line by three cables. The battery cable dimension differs depending on the UPS power ratings, provided that it meets the battery discharge current requirement when the battery voltage nears the EOD level, as shown in Table 3-1.

3.1.2 Maximum Steady State AC and DC Currents

The power cable must be selected according to the current and voltage values indicated in Table 3-1, as well as the local wiring regulations, as well as taking environmental conditions (temperature and physical media) into consideration; refer to Table 3B in IEC 60950-1.

Table 3-1 Max. steady state AC and DC currents

UPS power (kVA)	Rated current (A)				Bus stud bolt/nut specification		
	Max. input current ^{1,2}	Output/bypass current ² at full load			Battery discharge current (+, -, N) at min. battery voltage	Input/battery/output/bypass cable	Recommended torque (N.m)
		220V	230V	240V			
10 (3-in 1-out)	20	46	44	42	58	M6	3
20 (3-in 1-out)	44	91	88	85	58	M6	3



Note

When selecting the battery cables, a max. volt drop of 4Vdc is permissible at the current ratings given in Table 3-1. Avoid coiling the cables as this would increase the electromagnetic interference (EMI).

1. Input mains current for rectifier and bypass.

2. Non-linear load (like switch power) affects the design of output and bypass neutral line. The neutral line current may exceed the rated phase current, at most 1.5 times of the rated phase current.

3.1.3 Recommended CSA of UPS Cables and corresponding Lugs

The recommended CSA of the UPS cables is listed in Table 3-2.

Table 3-2 Recommended CSA of the UPS cable (unit: mm², ambient temperature: 25°C)

Model	Input	Output	Bypass	Neutral line	Earth cable	Battery
10 (3-in 1-out)	10	10	10	10	10	10
20 (3-in 1-out)	10	10	10	10	10	10



Note

When the system is in common input configuration and in 3-in 1-out mode, because phase A powers the load, the input cable of phase A must be selected according to Table 3-2. Input cables of phase B and phase C may refer to Table 3-2.

Lugs for Input, Output, Common / Split Bypass, Battery connections MUST be of Ring type cross-section, suited for Cables and Currents in use.

3.1.4 Selecting the UPS I/O Switch

Table 3-3 indicates the recommended UPS I/O switch capacity, the user may select it as required.

Table 3-3 Selecting the UPS I/O switch

Model	Input port	External input switch	BCB	Output port	External output switch
10 (3-in 1-out)	Terminal block	32A (3P)	63A	Terminal block	63A (2P)
20 (3-in 1-out)	Terminal block	63A (3P)	80A	Terminal block	125A (2P)

3.1.5 Distance Between the UPS Connection Point and the Floor

See Table 3-4 for details.

Table 3-4 Min. distance between UPS connection point and floor

UPS connection point	Min. distance (mm)
Rectifier input	1000
Bypass input	1000
AC Output	1100
Battery	1100
PE terminal	1100

3.1.6 Notes

The following points are provided for general guidance only. If there are corresponding local regulations, such regulations shall prevail.

1. The protective earth cable dimension shall be selected according to the AC power failure level, cable length and protection type. The grounding wire connection must use the shortest possible connection route.
2. In the case of cables that are required to handle large current, it may be easier to use multiple smaller cables in parallel.
3. When selecting the battery cable dimension, it is important to take the current value in Table 3-1 into account and bear in mind that the maximum permissible voltage drop is 4 Vdc.
4. Avoid coiling the cables as this would increase the electromagnetic interference (EMI).

3.1.7 Power Cable Connecting Terminal

The rectifier input, bypass input, output and battery power cables are connected to the corresponding terminals, as shown in Figure 3-2.

3.1.8 Protective Earth

The protective earth cable must be connected securely to the PE input terminal (see Figure 3-2) using the fastening bolt. All the cabinets and cable troughs shall be earthed according to the local regulations. The earthing wires shall be secured in order to prevent them coming loose from the fastening screws if they are pulled.



Failure to earth the various elements as directed may result in EMI, electric shock or fire risk.

3.1.9 External Protective Device

To ensure safety, it is necessary to install external circuit breakers on the UPS input and battery lines. Because no two installations are the same, this section is only intended to provide general practical guidelines for installation engineers. Qualified installation engineers should be aware of the local wiring regulations and any other related information

Rectifier and bypass input power supply

1. Input overcurrent and short circuit protection

Install suitable protective devices on the mains input supply distribution line. The protective devices should provide functions such as overcurrent protection, short circuit protection, isolation protection and tripping upon backfeed. When selecting the protective devices, consider the power cable current-carrying capacity, system overload capacity (see Table 10-6 and Table 10-7) and the short circuit capacity of the upstream power distribution.

2. Split bypass configuration

If the UPS adopts the split bypass configuration, independent protective device shall be installed on both the rectifier input and bypass input distribution lines.



1. The rectifier input and bypass input must use the same neutral line.
2. In the case of IT grid systems, a 4-pole protective device must be installed on the UPS external power distribution line.

3. Earth fault protection

If the upstream input power supply is fitted with an RCD, it is important to take the transient state and steady state earth leakage current upon the start-up of the UPS into account.

The RCCB shall meet the following requirements:

- Be sensitive to DC unidirectional pulses (class A) in the power distribution network
- Be immune to transient current pulses
- Have an average sensitivity of 0.3A - 3A (adjustable)

The RCCB symbols are shown in Figure 3-1.

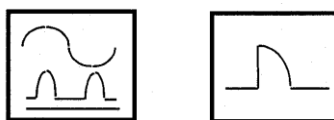

Figure 3-1 RCCB symbols

The UPS is fitted with an internal EMC filter, therefore the protective earth cable leakage current is 0 - 1000mA. We recommend confirming the RCD sensitivity of the upstream input power distribution and downstream power distribution (to the load) lines.

External battery

The BCB must be installed in order to protect external battery. The UPS requires an optional BCB box to provide overcurrent protection, short circuit protection and automatic tripping functions for the external battery. The rated voltage of the BCB is 500Vdc.

This BCB is extremely important for the battery maintenance, and is generally installed close to the battery.

System output

The UPS output distribution line must be fitted with a protective device. The protective device must be different from the input distribution protection switch and be able to provide overload protection (refer to Table 10-6 and Table 10-7).

3.1.10 Power Cable Connection Steps

For the UPS cable access mode, refer to 2.7.3 .

Connection terminals and cable routing method

Figure 3-2 shows the UPS power cable connection terminals. Figure 3-3 shows the power cable entry and routing methods.



Note

1. Open the appropriate holes on the rear protective cover before routing the power cables. Install cable guards around the rims of the hole to protect power cables against cutting.
2. Feed the power cables through the holes, then connect them to the corresponding terminals.

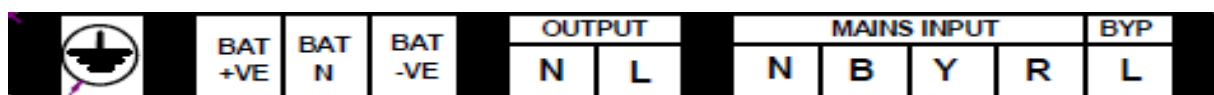

Figure 3-2 Power cable connection terminals (rear view)

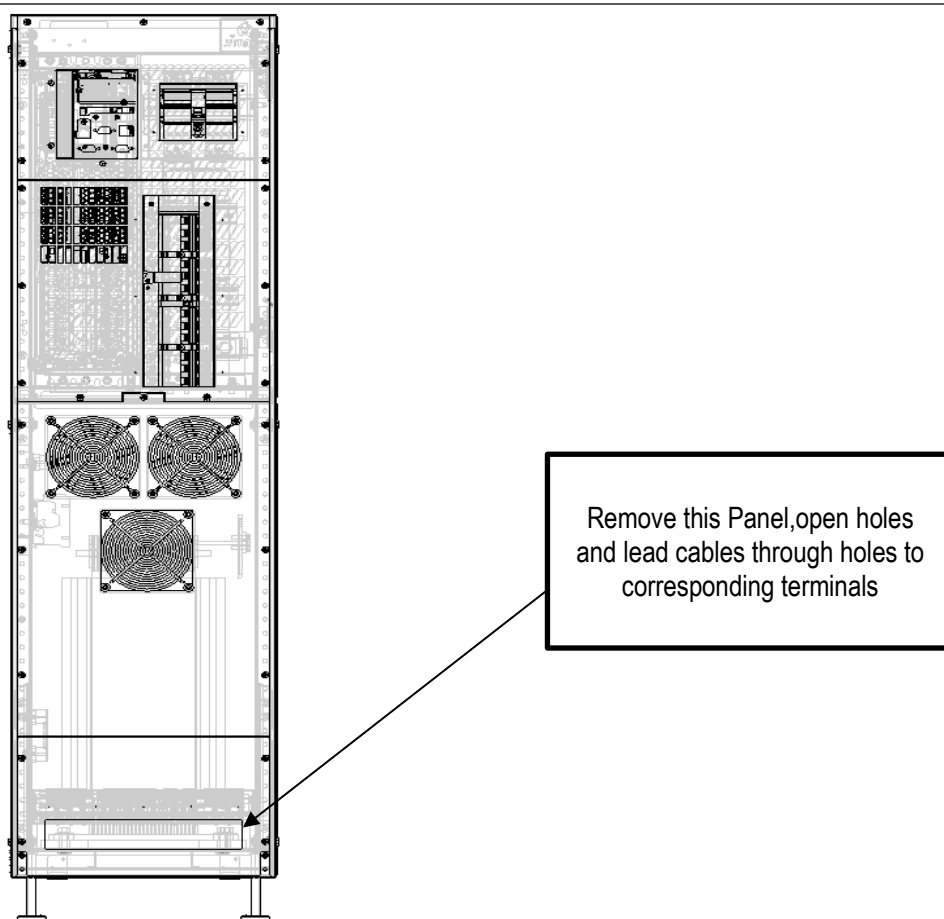

Figure 3-3 Power cables wiring diagram (rear cable access)



Warning

1. Before connecting the cables, make sure that all the external and internal UPS power switches are set to OFF, and post the appropriate warning signs to prevent inadvertent operation of the switches.
2. Measure the voltages between the UPS terminals, and the voltages between the terminals and earth.



Warning

1. The earth cables and neutral line must be connected in accordance with local and national codes of practice.
2. Failure to observe this condition may result in electric shock or fire risk.

Power distribution mode

Based on the user's requirements, it is possible to select one of the following I/O cable connection configurations:

- 3-in 1-out, common input configuration
- 3-in 1-out, split bypass configuration

Connecting the system input

1. 3-in 1-out, common input configuration (factory default)

Refer to Figure 3-4, connect the AC input cables to the three copper shorting bars between the rectifier input terminals (mA-mB-mC) and the bypass input terminals (bA-bB-bC) in the cabinet. Connect the input neutral line to the terminal N in the cabinet. Make sure that the phase rotation is correct.



Note

Note that the common input copper shorting bars are fitted before delivery.

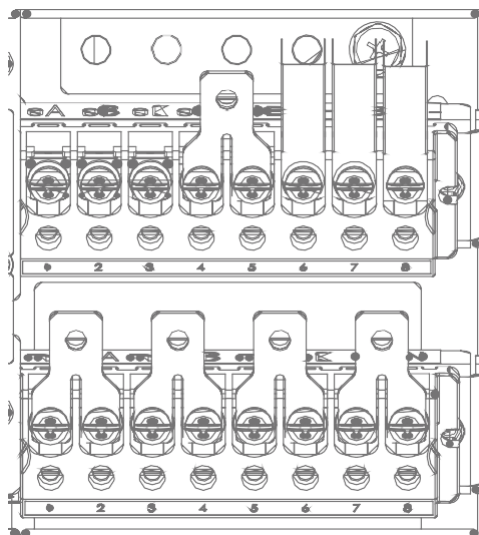

Figure 3-4 3-in 1-out, common input configuration cable connection (factory default)

2. 3-in 1-out, split bypass configuration

Refer to Figure 3-5, remove the three copper shorting bars between the rectifier input terminals (mA-mB-mC) and the bypass input terminals (bA-bB-bC). Connect the rectifier input cables to the rectifier input terminals (mA-mB-mC) in the cabinet, and connect the bypass input cables to the bypass input terminals (bA-bB-bC) in the cabinet. Connect the input neutral line to the terminal N in the cabinet. Make sure that the phase rotation is correct.

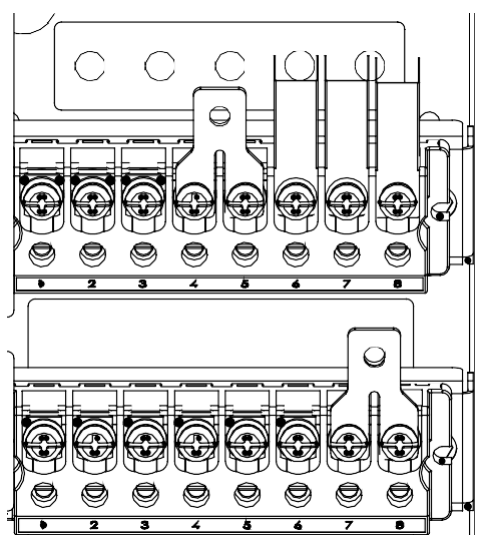

Figure 3-5 3-in 3-out, split bypass configuration cable connection

3. 3-in 1-out, common input configuration

For more details, refer to 8.2.7 .

4. 3-in 1-out, split bypass configuration

For more details, refer to 8.2.7 .

Connecting the system output

In the case of 3-in 1-out configurations, connect the system output cables between the output terminals (oA-oB-oC-oN) and the load; whereas, in the case of 3-in 1-out configurations, connect the system output cables between the

output copper shorting bars (oA-oB-oC), oN and the load. Refer to Table 3-1 for the tightening torque values. Make sure that the phase rotation is correct.



Warning

Prior to the service engineer's visit, if the load is not ready to be connected to the power supply, it is important to ensure the terminals of the output cables are insulated safely

Connecting the batteries

If the external battery is required, ensure correct polarity between the battery string terminals and the BCB, and between the BCB and the UPS cabinet battery input terminals (Bat+, N, Bat-), i.e. (Bat+) to (+), (Bat-) to (-) and (N) to (N).

This completes the connection procedure. At this point it is possible to replace the protective covers.



Note

After connection, take appropriate measures to seal the cable entry holes.

3.2 Wiring the Signal Cables

3.2.1 Overview

Depending on the specific on-site needs, the UPS requires auxiliary connections to manage the battery system (including the external battery circuit breaker), communicate with a PC, provide alarm signals for external devices, enable a remote EPO and/or the bypass back feed circuit breaker signal, and for parallel communication functions. These functions are performed by the communication box in the UPS cabinet. As shown in Figure 3-6, the communication box provides the following ports:

1. Intellislot port
2. Dry contact port
3. RS232 port
4. Ethernet port (not used)
5. Parallel/LBS port
6. REPO port
7. USB port
8. Multifunctional port

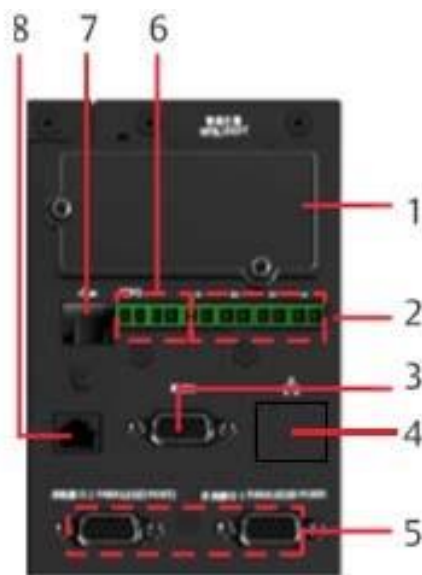

Figure 3-6 Illustration drawing of communication box ports

3.2.2 Dry Contact Port

The UPS provides five dry contact ports. The silkscreens of the five dry contact ports are 1 - 12. The pin layout of each dry contact port is shown in Figure 3-7, and the port description is shown in Table 3-5.

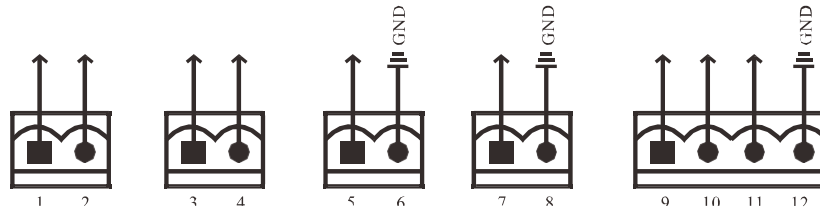

Figure 3-7 Pins of dry contact ports

Table 3-5 Description of the dry contact ports

Silkscreen	Port name	Pin NO.	Pin name	Meaning
1	Output port1	1	LOW_BATTERY/ON_BATTERY /ON_BYPASS/UPS_FAULT/ Main backfeed protection enabled	Default: LOW_BATTERY, can be set-up via the LCD settings page. Change main backfeed via Paramset. When there is an alarm active on the system, Pin 1 and Pin 2 are shorted together
		2	GND	GND
2	Output port 2	3	LOW_BATTERY/ON_BATTERY /ON_BYPASS/UPS_FAULT/ Bypass backfeed protection enabled	Default: UPS_FAULT, can be set-up via the LCD settings page. Change bypass backfeed via Paramset. When there is an alarm active on the system, Pin 3 and Pin 4 are shorted together
		4	GND	GND
3	Input port 1	5	Battery mode shut-down/Any mode shut-down (Remote Comms Shut-down)/ Maintain mode	Default: Maintain mode, can be set-up via the LCD settings page. When Pin 5 and Pin 6 are shorted together, the function is valid
		6	GND	GND
4	Input port 2	7	Battery mode shut-down/Any mode shut-down (Remote Comms Shut-down)/ Maintain mode	Default: Maintain mode, can be set-up via the LCD settings page. When Pin 7 and Pin 8 are shorted together, the function is valid
		8	GND	GND
5	REPO input port*	9	+5V	REPO power supply, 5Vdc 100mA
		10	REPO Coil -NC	NC, ECO activated when there is an open circuit between Pin 9 and Pin 10
		11	REPO Coil -NO	REPO triggered when there is a short circuit between Pin 11 and Pin 12
		12	GND	REPO ground

Note

*: I/O dry contact port rating: 125 Vdc, 0.5 A; 30 Vdc, 1 A.

The terminals corresponding to Pin 11 and Pin 12 are reserved for configuring the REPO function. The REPO device also requires a shielded cable for connecting the Normally Open remote REPO switch between the two terminals. If not required, you should disconnect Pin 9 and Pin 10. Pin 9 and Pin 10 have been shorted together before delivery.

Note

Activating the UPS EPO will deactivate the rectifier, inverter and static bypass, but does not disconnect the UPS from the mains input. If you wish to disconnect the UPS completely, it is also necessary to open the input MCB installed upstream of the UPS when activating the EPO.

In the event of an emergency, close the REPO switch (supplied and installed by the user) in order to shut down the rectifier and inverter, and switch the UPS off. Under normal conditions, the REPO switch cannot be used to isolate the UPS from the mains input power. If an electronically controlled circuit breaker function is installed at the UPS input, the REPO switch can be used to trip this breaker, thus cutting off the UPS mains input power. The position of the REPO switch is shown in Figure 3-6, and the REPO cable connection is shown in Figure 3-8.

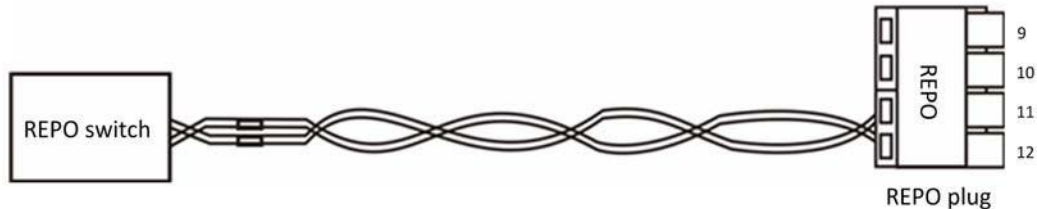

Figure 3-8 Connecting the REPO cable

The cable connection procedures are as follows:

1. Release the REPO port connection terminals '11' and '12'.
2. Strip the insulation from the ends of the two copper core cables and insert them in the REPO port connection terminals '11' and '12', and press the terminals down in order to secure the cables. The REPO cable connection procedure is complete. Ensure that the REPO cable is connected securely in order to ensure that the REPO is not activated inadvertently as the result of poor contacts.
3. In the case of parallel UPS systems, when connecting the REPO cable, users should connect terminal '11' of the REPO port in parallel to one terminal of each electronic switch, and terminal '12' of the REPO port in parallel to the other terminal of each electronicswitch.

When the REPO switch at the user end is closed, the UPS will generate an alarm and cut off the output immediately, and the UPS will not return to the normal operating state automatically. At this point, it is necessary to change the REPO switch state, and switch the UPS on manually.



Note

1. We recommend using 0.82mm² - 0.33mm² copper core cable (18AWG - 33AWG signal cable).
2. If the REPO has been configured to trip an electronically controlled circuit breaker switch, after the REPO has been activated it will be necessary to re-arm the switch before restarting the UPS.

3.2.3 RS232 Communication Port

To connect the serial port communication cables, proceed as follows:

Insert one end of the DB9 serial port communication cable into the DB9 serial port (see port 3 in Figure 3-6) on the rear panel of the UPS, and connect the other end to the DB9 port on the computer.

The pin functions of the DB9 port are listed below:

Pin No.	Function
2	Send data
3	Receive data
5	Common terminal

3.2.4 USB Communication Port

The position of the USB port is shown in Figure 3-6.

To connect the UPS communication cables, proceed as follows:

Insert one end of the USB communication cable into the USB port on the UPS, and connect the other end to the USB port on the computer.

After connecting the cable, it is necessary to install the USB drive program on the installation disk.

3.2.5 Parallel/LBS Communication Port

The position of this port is shown in Figure 3-6.

3.2.6 Intellislot Port

The position of this port is shown in Figure 3-6. The Intellislot port is used for installing optional cards, including the SIC card, UNITY card, etc. The Intellislot port can be used together with other ports.

3.2.7 Multifunction port

The multifunction port uses the standard RJ45 port, which supports the Modbus/Jbus protocol and can be used to connect the VERTIV temperature & humidity sensor. The user can enable Modbus/Jbus protocol function or sensor function via the 'Settings' on the LCD.

3.2.8 Signal Cable Connection Steps



Note

Route the power and signal cables respectively. The signal cable shielding sheath must be earthed securely.

Rear cable access mode is available. See Figure 3-10 for a detailed description of the wiring method.

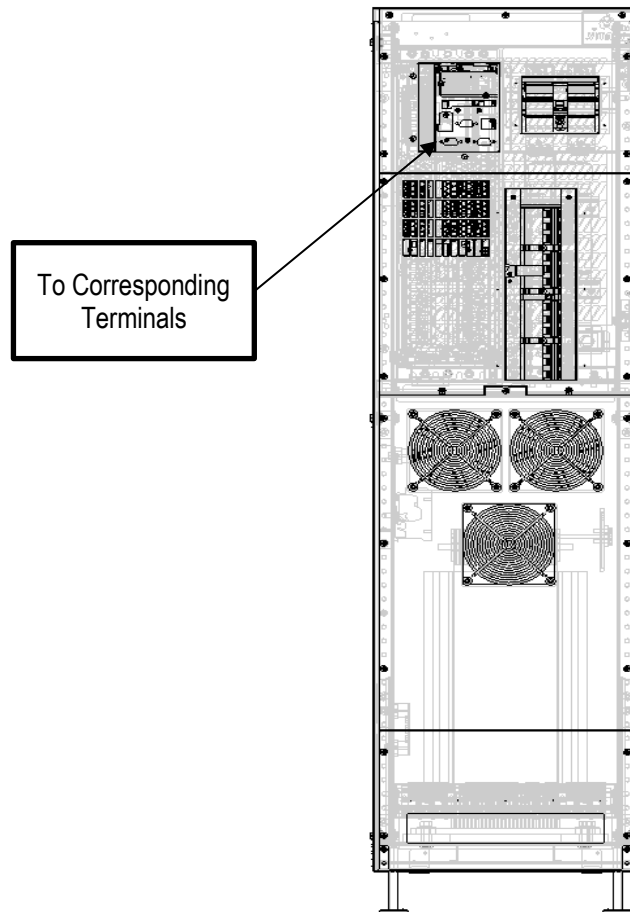

Figure 3-10 Signal cables wiring route (rear cable access)

Chapter 4 Operator Control and Display Panel

This chapter introduces the functions and use of the components on the UPS operator and display panel, and provides LCD display information, including the LCD screen types, detailed menu messages, prompt windows message and UPS alarm list.

4.1 Introduction

The operator and display panel is located on the front panel of the UPS. The operator and display panel allows the user operate and monitor the UPS, and view the UPS parameters, Ups and battery status information and any alarm messages.

As shown in Figure 4-1, the operator and display panel includes an LCD screen, menu keys, and LED indicators (run indicator and alarm indicator).



Figure 4-1 Operation and display panel



Note

The device includes a gravity sensor function, so that the LCD display direction will adapt to the device layout mode.

4.1.1 LED Indicators

The LED indicators consist of the run indicator and alarm indicator. Table 4-1 provides a description of these indicators.

Table 4-1 Description of LED indicators

Indicator	Colour	State	Meaning
Run indicator	Green	On	UPS output present
		Blinking	Inverter is starting
		Off	UPS output not present, inverter is starting
Alarm indicator	Yellow	On	Alarm active
	Red	On	Fault present
	/	Off	No alarms, no faults

4.1.2 Audible Alarm (Buzzer)

UPS operation is accompanied with the following two different kinds of audible alarms, as described in Table 4-2.





Table 4-2 Description of audible alarm

Sound	Meaning
Continuous beep	This sound is generated in the event of a UPS fault condition, such as a fuse or hardware failure
One beep every 0.5 seconds	This sound is generated in the event of a critical UPS alarm condition, such as an Inverter overload
One beep every second	This sound is generated in the event of a critical UPS alarm condition, such as low battery voltage
One beep every 3.3 seconds	This sound is generated in the event of a general UPS alarm condition

4.1.3 LCD and Function Keys

The operator and display panel includes five function keys, the respective functions are described in Table 4-3.

Table 4-3 Description of control buttons

Function key	Silkscreen	Description
Confirm		Used to confirm or enter
Up		Used to scroll up, scroll left or increase value, etc.
Down		Used to scroll down, scroll right or reduce value, etc.
Exit		Used to go back, exit, cancel or forbid operation
Power		Used to switch on, switch off or transfer to Bypass mode

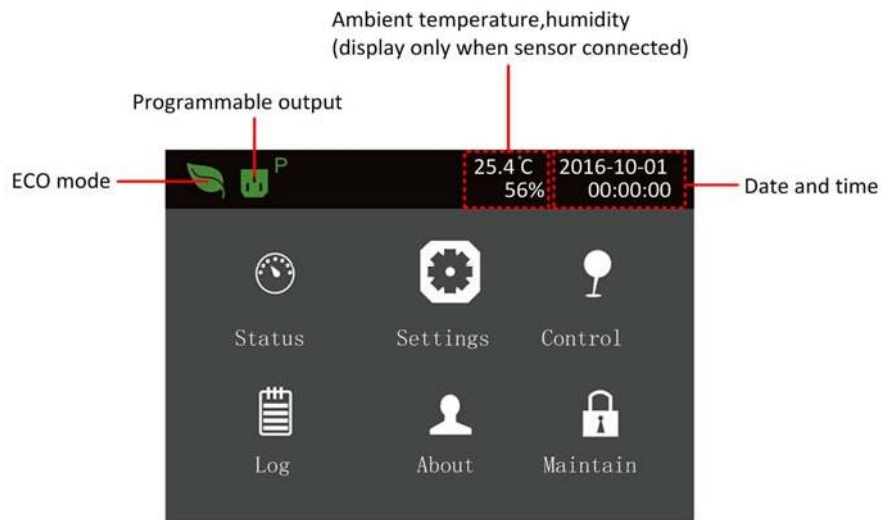

Figure 4-2 LCD screen

The LCD includes a user-friendly interface and a 320 × 240 dot matrix image display. Thanks to the user-friendly, menu-oriented LCD it is possible to browse easily through the UPS input, output, load and battery parameters, obtain information about the current UPS status and alarm messages, as well as performing functional setting and control operations. The LCD also stores historical alarm records that can be retrieved for reference and diagnosis.

4.1.4 Initial Start-up Guide

When the UPS is in the initial start-up phase, the interface shown in Figure 4-3 will appear to guide the user through the basic UPS parameter setting procedure.



Figure 4-3 Initial Start-up Guide (1)

Welcome page

Click Next to start the guide procedure.

Language, date and time page

On this page, you can set-up the language, date and time as required.

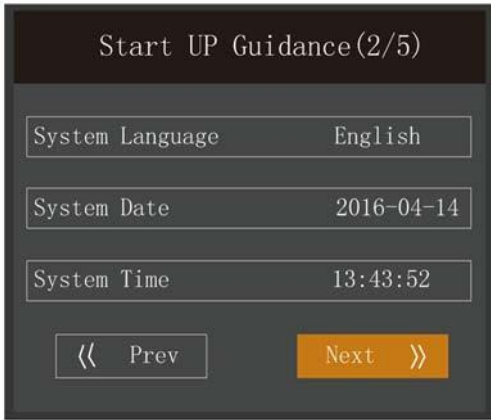

Figure 4-4 Initial Start-up Guide (2)

Battery parameter page

On this page, you can set-up the battery cell number and total Ah. The available settings are 24, 32 and 40. See the right hand diagram in Figure 4-5.



Figure 4-5 Initial Start-up Guide (3)

If there is an external battery module, the 'Local battery total Ah' will not appear, see Figure 4-6.

Output page

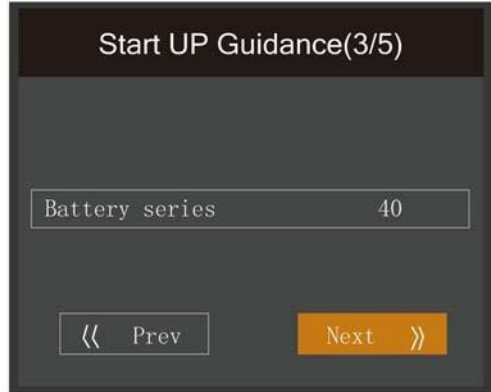

Figure 4-6 Initial Start-up Guide (3)

As shown in Figure 4-7, you can set-up the output voltage, output frequency, and output phase. The 'Output phase No.' may be set to 'single' or '3 phases'. See the right hand diagram in Figure 4-7.

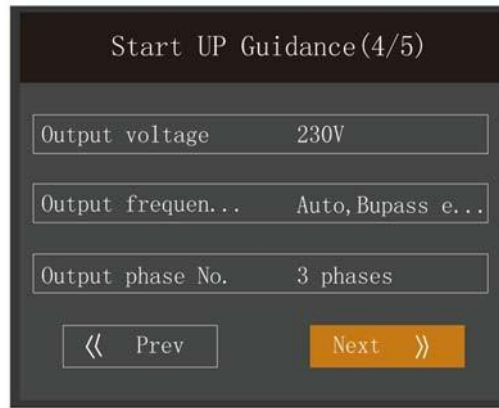

Figure 4-7 Initial Start-up Guide (4)



Note

In the case of the output page, the REPO terminal (forcible output shut-down) must be unplugged when carrying out the settings, otherwise the interface shown in Figure 4-8 will appear.

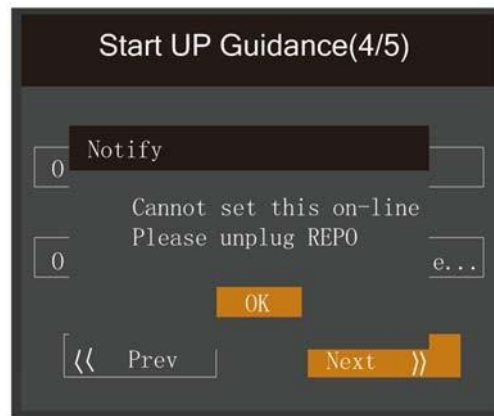

Figure 4-8 Prompt for removing REPO terminal

End page

The interface shown in Figure 4-9 will appear. This means that the function keys and LCD are invalid; the user cannot continue with the operation. Please switch the UPS off based on the prompt shown in Figure 4-10, confirm that the actual wiring method applied to the output terminal is consistent with the method selected during the set-up procedure, and then switch the UPS on again.

After start-up the user will be able to operate the UPS normally.

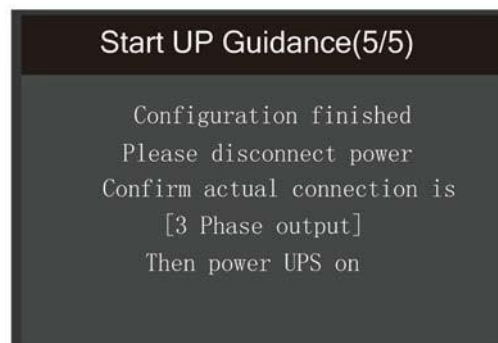

Figure 4-9 Initial Start-up Guide (5)

4.2 LCD Menu Structure

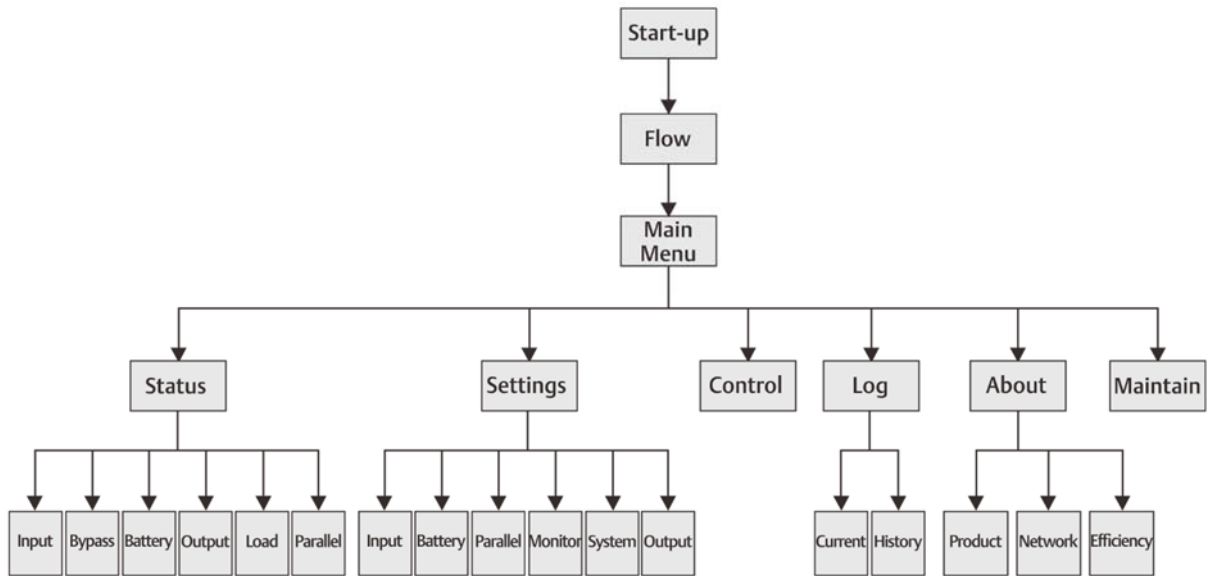

Figure 4-10 LCD menu structure

4.3 LCD Screen Types

4.3.1 Start Screen

When the UPS is started up it performs a system self-test, during which the Start Screen is displayed for approximately 10 seconds, as shown in Figure 4-11.



Figure 4-11 Start screen

4.3.2 Flow Screen

Once the UPS self-test is complete, the flow screen shown in Figure 4-12 will appear.

The flow screen provides a total status overview of the UPS, including the input, bypass, rectifier, battery, inverter and output, etc. Operating modes are displayed in colour, while invalid are displayed in grey.

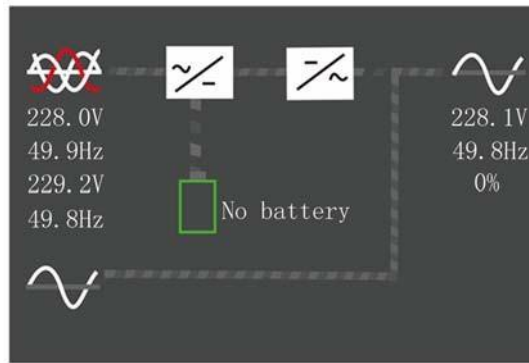

Figure 4-12 Flow screen

Press the **Enter** key on the flow page to access the primary screen.

4.3.3 Main Menu Screen

The main menu screen consists of six icons: Status, Settings, Control, Log, About, Maintain. As shown in Figure 4-13.



Figure 4-13 Main menu screen

Press the **Esc** key on the main menu screen to return to the flow screen. Press the **▲** or **▼** key to move the cursor and select the required sub-menu, then press the **Enter** key to confirm it.

4.3.4 Sub-menu Screen

The sub-menu screen contains the UPS parameters and item settings.

After accessing the sub-menu screen, if there is a tab control, just move the cursor to the tab. At this point, you can

press the **▲** or **▼** key to switch the tab. Press the **Enter** key to move the cursor to a specific item.

After accessing the sub-menu screen, if there is no tab control, the cursor will stop on a certain Item.

Press the **Esc** key to return to the previous screen.

For more details about the sub-menu screen, see following pages.

Status page

The Status page contains information about the Input, Bypass, Battery, Output and Load.

See below:



Input	Bypass	Battery	Output
L-N voltage (V)	230	230	230
L-N current (A)	0.59	0.31	0.96
Frequency (Hz)	48.98	48.98	48.98
L-L voltage (V)	380	380	380
Power factor	0.27	0.00	0.22
Energy (kWh)	2.768		

Input	Bypass	Battery	Output
L-N voltage (V)	230		
Frequency (Hz)	48.98		

Input	Bypass	Battery	Output
Battery status	NoBatt	NoBatt	
Battery voltage (V)	0.00	0.00	
Battery current (A)	0.00	0.00	
Backup time (Minut...)	0.0		
Remaining capacit...	0		
External battery c...	0		

Input	Bypass	Battery	Output
L-N voltage (V)	230		
L-N current (A)	0.00		
Frequency (Hz)	0.00		

Load	
Sout (kVA)	0.00
Pout (kW)	0.00
Power factor	0.00
Load percent (%)	0

Settings page

The Settings page can be used to access the Output, Battery, Parallel, Monitor, System, and Outlet settings. For details about the setting up the parameters, refer to Appendix 1 .

See below:

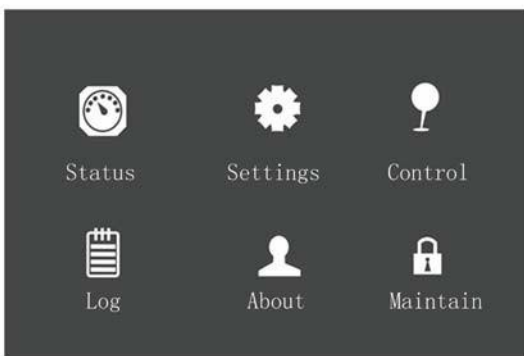

Output	Battery	Parallel
Voltage selection	230V	
Startup on bypass	Disable	
Frequency selection	Auto, Byp...	
Inverter sync range	±3.0Hz	
Bypass voltage upper limit	+20%	
Bypass voltage lower limit	-40%	
Bypass frequency range	±10%	

Output	Battery	Parallel
Run mode	Normal	
Output phase No.	3phase	

Output	Battery	Parallel
Shared battery	Disable	
Local battery total AH	9 AH	
External battery cabin...	AutoTest	
Low battery time	2 min	
Battery replaced time	2016-10-0...	
Battery test interval	Disable	
Battery test weekday	Wednesday	

Output	Battery	Parallel
Battery test time	00:00:00	
Battery series	20	
Dischg protret time	4320min	
Equal charge enable	No	
Temp compensation	Disable	
Replace battery		

Output	Battery	Parallel
Voltage selection	230V	
Frequency selection	Auto, Bypa...	
Run mode	Normal	
Redundant	YES	
System parallel num	1	
Output phase No.	3phase	
Sync parallel parameters		

Monitor	System	Outlet
Language	English	
Date	2016-10-01	
Time	00:00:00	
Display orientation	Auto- rota...	
Audible alarm	Enable	
Control port protocol	Sensor	
Modbus address	1	

Monitor	System	Outlet
IPv4 address	192.168.1.10	
Subnet mask	255.255.255.0	
Gateway address	192.168.1.1	
Bluetooth reset		
Change settings password		

Monitor	System	Outlet
Auto restart	Enable	
Auto restart delay	10 sec	
Guaranteed shutdown	Disable	
Remote control	Enable	
Remote power on delay	0 sec	
Remote shutdown delay	0 sec	
Redundant	YES	

Monitor	System	Outlet
LBS select	Disable	
IT system compatibility	Disable	
Dry connect 1 (Output)	Low battery	
Dry connect 2 (Output)	UPS fault	
Dry connect 3 (Input)	Maintain...	
Dry connect 4 (Input)	Maintain...	

Monitor	System	Outlet
Turn off		
Reboot		
Turn off when UPS over...	No	
<input type="checkbox"/> Turn off when UPS on...	2min	
<input checked="" type="checkbox"/> Turn off when backup...	0min	
<input checked="" type="checkbox"/> Turn off when batter...	30%	
<input checked="" type="checkbox"/> Turn on when powerr...	0min	

Control page

The Control page may be used to access the Turn ON/OFF/to BYPASS, Manual battery test, etc. functions. See below:

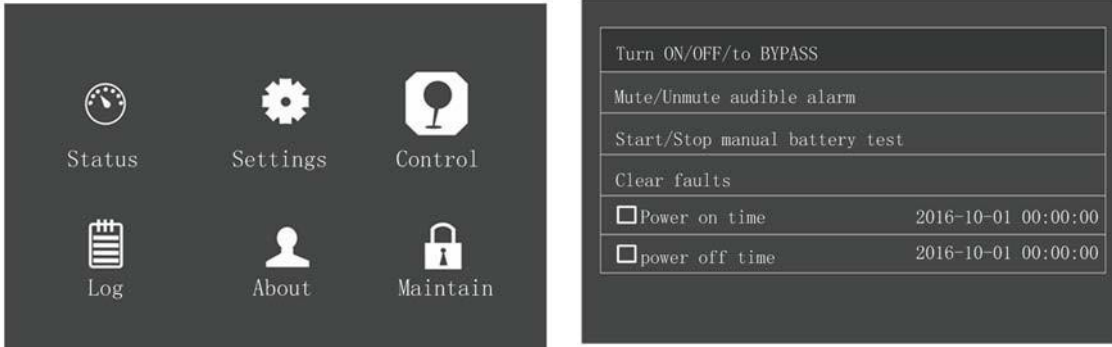

Log page

The Log page can be used to access a list of current and historical UPS events. See below:

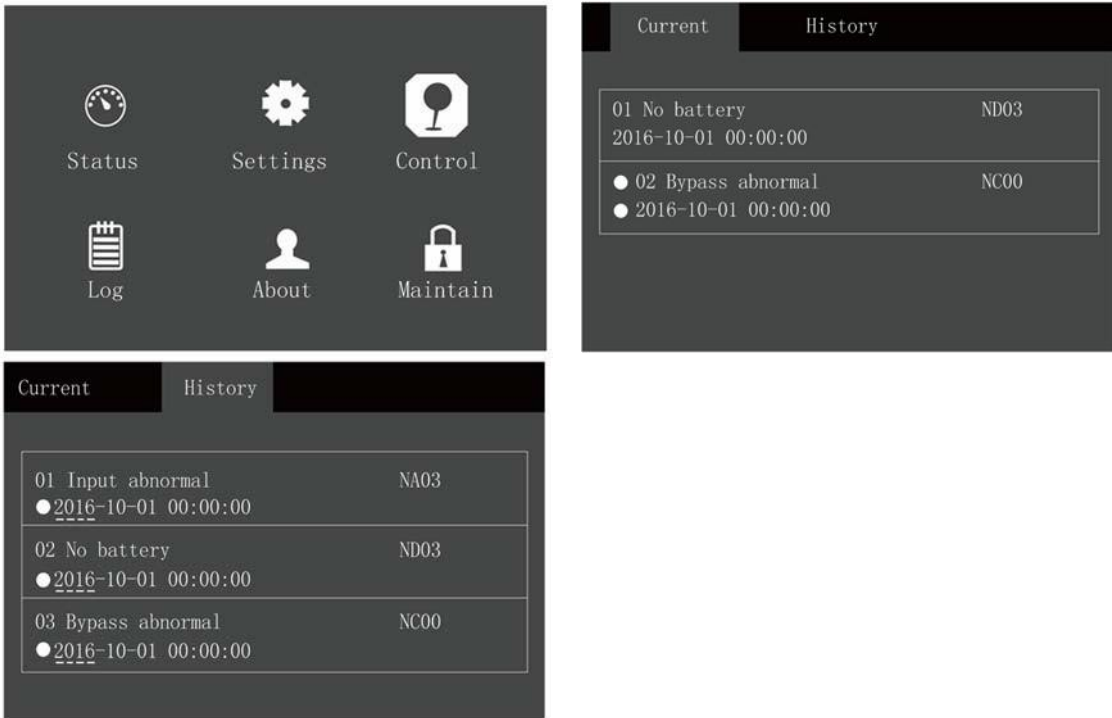

About page

The About page contains information about the Product, Network, and Efficiency. See below:

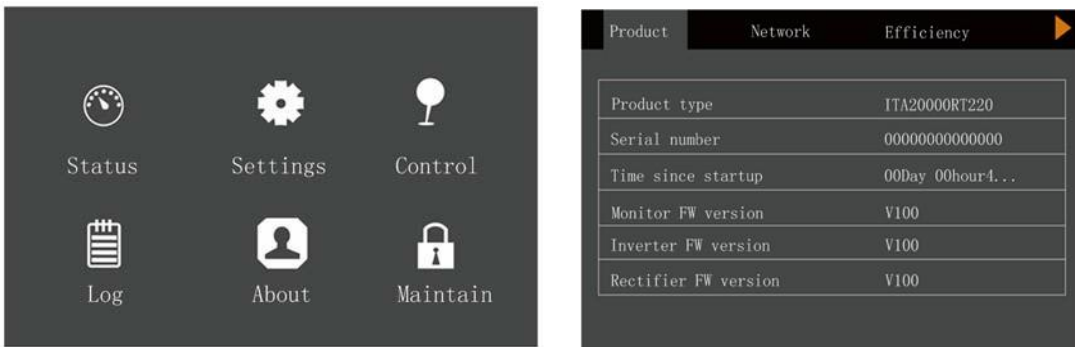



Maintain page



Note

The Maintain page is password protected and reserved for use by VERTIV service engineers only.

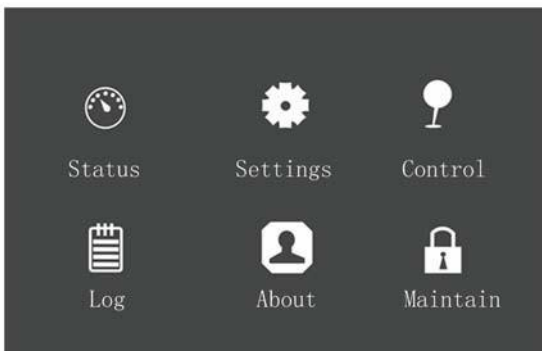

4.3.5 Default Screen

During the UPS operation, if there is no alarms for two minutes, the display will revert to the default as shown in Figure 4-14. While the Default screen is displayed, if there are no alarm or fault conditions active, the Flow screen shown in Figure 4-12 will be displayed if the user presses any key.



Figure 4-14 Default screen

4.4 Prompt Window

A prompt window is displayed while the system is in operation to alert you to certain conditions and/or request you to confirm a command or other operation. Table 4-4 lists the prompts and the associated meanings.

Table 4-4 Prompts and meanings

Prompt	Meaning
System setting is different, please check	When the parallel parameters are different, this prompt will appear
Cannot set this on-line, please shut down output	If the user attempts to change certain important settings while the output is active (output voltage, output frequency, output phase No.), this prompt will appear
Incorrect password, please input again	This prompt will appear when the user enters an incorrect Settings password
Operation failed, condition is not met	This prompt will appear when the user attempts to execute a certain operation, but the necessary condition is not met
Password changed OK	This prompt will appear when the user has changed the Settings password successfully
Fail to change password, please try again	This prompt will appear when the user attempts to change the Settings password but has failed to the same new password twice
The time cannot be earlier than system time	This prompt will appear when the user sets the 'Turn on delay' or 'Turn off delay' value to a time earlier than the current system time
Turn on failed, condition is not met	This prompt will appear when the user presses the power button (or executes the 'Turn on/Turn off/to Bypass' command on the 'Control' page).
Cannot set this on line, please unplug REPO	This prompt will appear if the user attempts to change output phase No. while the output is active
Please disconnect power, check output: 1 phase, 3 phase, then power UPS on	This prompt will appear when the output phase is changed. To ensure safety, the system requests the user to switch the UPS off and check the cable connections, and then switch the UPS on again

4.5 UPS Alarm Message List

Table 4-5 lists all the UPS alarm messages based on the 'Current' and 'History' menus.

Table 4-5 UPS alarm message list

Alarm message	Description
Communication fail	Internal communication is abnormal, please check whether the communication cables are connected correctly or not
Rectifier fault	The rectifier is faulty and is not running
DC/DC fault	The discharger is faulty, because the bus voltage exceeds the setting range when discharger starts or soft starts
DC bus abnormal	The inverter is off when DC bus voltage is faulty. The load will transfer to bypass, if the bypass is available
Charger fault	The battery charger output voltage is abnormal, and the charger is off
Aux. power fault	The auxiliary power output voltage exceeds the normal range
Input backfeed	Battery mode. The mains relay is shorted and the difference between the mains and battery voltage is less than the setting range
Inverter fault	The inverter is off when the inverter output voltage and current exceed the setting range. If the bypass is available, the UPS will transfer to bypass mode, otherwise the system will switch off
Output short circuit	Check for short circuits between the output cables
Bypass backfeed	Battery mode. The bypass relay is shorted or the SCR is damaged
Output off, voltage is not zero	The Output is switched off, but the system detects the presence of a voltage at the output terminals
Inverter relay shorted	The inverter relay is short circuited
Parallel No. abnormal	The on-line parallel number is inconsistent with the value in the settings. Please check that the parallel number on the 'Settings' page is the same as the actual on-line number, and that the parallel cables are normal
Parallel comm fault	The local UPS and its on-line frequency configuration is different or there is a conflict with the parallel address. Please check that the parallel system parameter setting is the same as the local parameter setting
Parallel cable connection abnormal	The system has detected that the parallel cables are not secure

Alarm message	Description
Input neutral lost	The AC input mains N line has not been detected. Please check whether the input N line has been interrupted or disconnected
Input ground lost	Check whether the PE line is connected securely, and that the alarm can be cleared on line
Input phase reversed	The mains AC input phase is reversed. Normally, phase B lags phase A by 120 degrees, and phase C lags phase B by 120 degrees. Check that the UPS mains input phase sequence is correct. If not, correct it
Input abnormal	The rectifier and charger have switched off because the mains voltage and frequency values exceed the normal operating range. Check whether the rectifier input phase voltage and frequency exceed the normal range or the mains power has been switched off
Rectifier overload	The output power exceeds the rectifier overload point. Check that the input voltage meets the output load requirement, a mains input range 176V - 100V corresponds to a load range of 100% - 50%, with linear derating
Battery reversed	The battery positive and negative terminals have been inverted. Please reconnect the battery and check the battery cable connections
Battery low pre-warning	This alarm is generated when the battery reaches the EOD (End Of Discharge voltage). The battery will continue to provide full load discharge capacity for another two minutes after this warning appears. The user can set this value ranging from 2min ~ 30min, (2 min by default). Please shut down the load as quickly as possible
Battery voltage abnormal	When the battery is connected, the system checks whether the battery voltage exceeds the normal setting range. Check whether the battery terminal voltage exceeds the normal setting range
No battery	Check the battery and battery cable connections
Battery series not qualified	The actual number of connected battery cells differs from the setting. Modify either the number of batteries or the setting so that these two values are consistent
Battery aged	The battery capacity is less than 25% of the initial value. Battery replacement is recommended
Battery test fail	The battery low voltage is detected during the manual or periodic battery self-test. Battery replacement is recommended
Battery overtemp	The battery ambient temperature is too high. Check whether the battery ambient temperature exceeds the setting value of 40 - 60 ^a (default: 50 ^a)
Battery cabinet not connected	The battery cabinet is not connected to the system
Fan fault	At least one fan is faulty. Check whether the fan is blocked or the cables have been disconnected
System overtemp	The internal heat sink temperature is too high, and the inverter has been switched off. This alarm may only be cancelled by reducing the heat sink temperature of each module to within the setting range. The system will restart automatically once the fault has been resolved. In the event of overheating, please check: 1. If the ambient temperature is too high 2. If the ventilation holes are blocked by dust 3. That the fans are working correctly
Inverter overload	The inverter load demand exceeds the rated value, the overload delay time has expired, and the inverter has shut down. If the bypass is available, the UPS will transfer to bypass mode, otherwise the output to the load will be interrupted. Check that the current inverter load demand, if it is overloaded, simply reduce the load demand and the system will revert to inverter mode five minutes after the alarm condition has been cleared
Bypass phase reversed	The bypass voltage phase sequence is reversed. Normally, phase B lags phase A by 120 degrees, and phase C lags phase B by 120 degrees. Check that the UPS bypass input phase sequence is correct. If not, correct it
Bypass overcurrent	The bypass current exceeds the rated value. The overload delay time has expired and the inverter has shut down
Parallel bypass cable connection abnormal	The bypass phase number is different from the output phase number indicated on the 'Monitor' page. Please check that the bypass cable connection is the same as the configured phase number
Bypass abnormal	This may be caused by the bypass voltage and frequency being outside the acceptable range, the bypass being switched off or by the bypass cables being connected incorrectly 1. Check that the bypass voltage and frequency are within the setting range. 2. Check the bypass cable connections
Bypass abnormal in ECO mode	ECO mode is available, and the bypass voltage and frequency are outside the setting range. Check that the bypass input voltage and frequency are within the setting range.
Output LPE short	There is a short circuit between the output and the enclosure. Check for short circuits between the output cables and the enclosure

Alarm message	Description
Output pending	Remote shut-down has been enabled, and the system will be switched off
Output disabled	The system is in the standby state, and the shut-down dry contact has been enabled. Check whether the shut-down dry contact has been enabled or not
Version incompatible	The monitoring board and DSP board versions are incompatible
Electrical leakage alarm	Short circuit between bus and enclosure or between battery and enclosure. Check for short circuits between the bus or battery cables and the enclosure
On maintenance bypass	The maintenance bypass state dry contact has been activated
Battery mode	The UPS is in battery mode, and the inverter starts running
Bypass mode	The UPS is in bypass mode
System overload	The parallel system load demand exceeds the max. load capacity of the parallel sets. Check the parallel system load demand, and if the system is overloaded, simply reduce the load
Loss of redundancy	After parallel redundancy has been enabled, the system load demand exceeds the rated load capacity (the load capacity is equivalent to the total capacity of the on-line sets, minus one)
Load sharing abnormal	Load sharing is abnormal in the parallel system
System parallel settings async.	Check that parallel setting parameters of each unit are consistent
Local parallel settings async.	Check that the Settings pages for the local unit and the other units are consistent
LBS abnormal	Check that the LBS cables are normal, the system is in stand-by mode, or that the system is in bypass mode and it is not possible to trace the bypass
REPO	The UPS has been shut down because the Normally Closed REPO terminal contact has been opened
Bypass phase reversed	In parallel connection configuration, the bypass phase sequence is not consistent. Check the parallel bypass cable connections
System battery low pre-warning	In a parallel system, there is a battery voltage low warning for all the devices supplied by the battery inverter
Battery test started	The periodic battery self-test or manual self-test is in progress
Battery test stopped	The periodic battery self-test or manual self-test is complete
EOD turn off	The inverter has switched off because EOD has been reached. Check the mains power-off state and restore the mains in time
Guaranteed shut-down	In forced EOD mode, then system shuts down once the battery is fully discharged
Shut-down due to overtemp	During the UPS operation, the system checks whether the heat sink temperature exceeds the setting range. In the event of overheating, please check: 1. If the ambient temperature is too high 2. If the ventilation holes are blocked by dust 3. That the fans are working correctly
Remote shut-down	Dry contact activated causes shut-down irrespective of operating mode
Remote power-on	UPS switched on remotely
Remote shut-off	UPS switched off remotely
Load off due to shut-down on battery	Shut-down in battery mode
Output off due to bypass abnormal	The bypass is abnormal, and has switched from the working state to the standby state. Check that the bypass input is normal
Battery to utility transition	The UPS is powered by the mains instead of the battery
Manual power-on	Set power-on via LCD panel
Manual shut-down	Set shut-down via LCD panel
Operating on inverter	The UPS output is supplied by the Inverter
Battery series set to (32-40)	The number of battery cells has been modified
Restore factory defaults	With the UPS in standby mode, select the 'Restore Factory Defaults' function on the Maintain page
Output phase No. set to 1	The output phase has been changed from 3-phase to 1-phase

Alarm message	Description
Output phase No. set to 3	The output phase has been changed from 1-phase to 3-phase
UPS out of service	The UPS is out of service
Switch on programmable output	The programmable output status has been changed from Switch Off to Switch On
Switch off programmable output	The programmable output status has been changed from Switch On to Switch Off
System parallel settings start sync	Set the 'Sync parallel parameters' command manually to activate the event
Local settings sync OK	The local parameters have been synchronized successfully
System settings sync OK	All the parameters have been synchronized successfully
Load off due to output short	There is a short circuit on the inverter or bypass output Carry out the appropriate checks
Output off due to overload & bypass abnormal	The output has been switched off due to an overload and the bypass supply is abnormal. Carry out the appropriate checks
Parallel No. abnormal	The parallel on-line number and the configured value are inconsistent Please check that the parallel number on the 'Settings' page is the same as the actual on-line number, and that the parallel cables are normal
Bypass disabled	If Settings->Output->Frequency is set to 'Auto, BypDisa; 50Hz, BypDisa; 60Hz, BypDisa', the LCD will generate the BypDisa alarm
In intelligent sleep mode	<p>When intelligent sleep mode is enabled, the system may perform N sets of inverter start-up.</p> <p>Conditions for entering sleep mode:</p> <ul style="list-style-type: none"> - The UPS must be connected to a common, large battery string (if there is no large battery string, entering sleep mode will result in the charger failing to recharge the battery), - sleep mode must be enabled on the host, - there must be no faults or alarms active on the inverter or rectifier, - the battery must not require recharging, - a period of at least 1 hour must have elapsed since last exiting sleep mode, - the unit is not the master unit - with the exception of the module in sleep mode, the local unit ID number has not received a start-up command within the last 5 minutes. <p>When the N minus 2 unit rated load is larger than the existing system rated load capacity, the unit with the largest ID number starts to enter sleep mode (inverter off), at this point, N minus 1 units are operating in inverter mode.</p> <p>When the N minus 3 units are larger than the current system rated load capacity, the unit with the largest ID number remains in sleep mode</p>
Battery cabinet connection abnormal	The system detects that there are more than six battery cabinets connected and indicates that the battery cabinet connection is abnormal
Battery cabinet not connected	The battery cabinet group number is specified, but the communication cables are not connected
Battery EOD	Battery end of discharge voltage reached
Faults cleared	Press the 'Clear faults' button on the 'Control' page, the system then records this event
Manual shut off	After the user shuts down the UPS output, the system will record this event
System warning	In the case of parallel systems, this alarm is generated when the UPS auto-adapting output frequency is inconsistent. Solution: Switch on again
System fault	This alarm occurs when the model identification is incorrect. Solution: Contact service manager

**Note**

If the alarm is generated as the result of a software value set-up by an authorised VERTIV engineer, and you wish to modify the setting, please get in touch with your local VERTIV customer service centre.

Chapter 5 Operating Procedures

This section introduces the operating precautions and describes the UPS operating procedures in detail.

5.1 Brief Introduction

5.1.1 Precautions



Important

The user may only carry out the operations described in this section once the authorised service engineer has switched the UPS on for the first time and completed the commissioning tests



Warning: hazardous mains and/or battery voltage

1. No user serviceable parts are located behind the protective covers that can only be removed by using tools. Only qualified service personnel are authorized to remove such covers.
2. Hazardous voltages may be present on the UPS AC input and output terminals at any time. If the cabinet is equipped with an EMC filter, hazardous voltages may be present on the filter.

1. For information about the control keys and LCD related to all the operating steps, refer to *Chapter 4* .
2. During operation, the buzzer alarm may be activated at any time. Press the  key for 3s to silence the audible alarm.
3. When the UPS is equipped with traditional lead-acid batteries, the system provides the optional boost charge function. If lead-acid batteries are used, when the mains returns after an extended mains failure, the battery charging voltage will be higher than the normal charging voltage, this is normal, and the charging voltage will return to its normal value after a few hours.

5.1.2 Power Switch

Open the front door of the UPS cabinet to access the power switches, as listed below, (see Figure 5-1):

Q1: Rectifier input switch - connects the UPS to the main power supply.

Q2: Bypass input switch - connects the UPS to the bypass power supply.

Q3: Maintenance bypass switch(lockable) - supplies power to the load when UPS is being serviced.



Note

If the UPS system consists of more than 2 UPS modules in parallel, do not use the internal maintenance bypass switch

Q5: Output switch - connects the UPS output to the load.

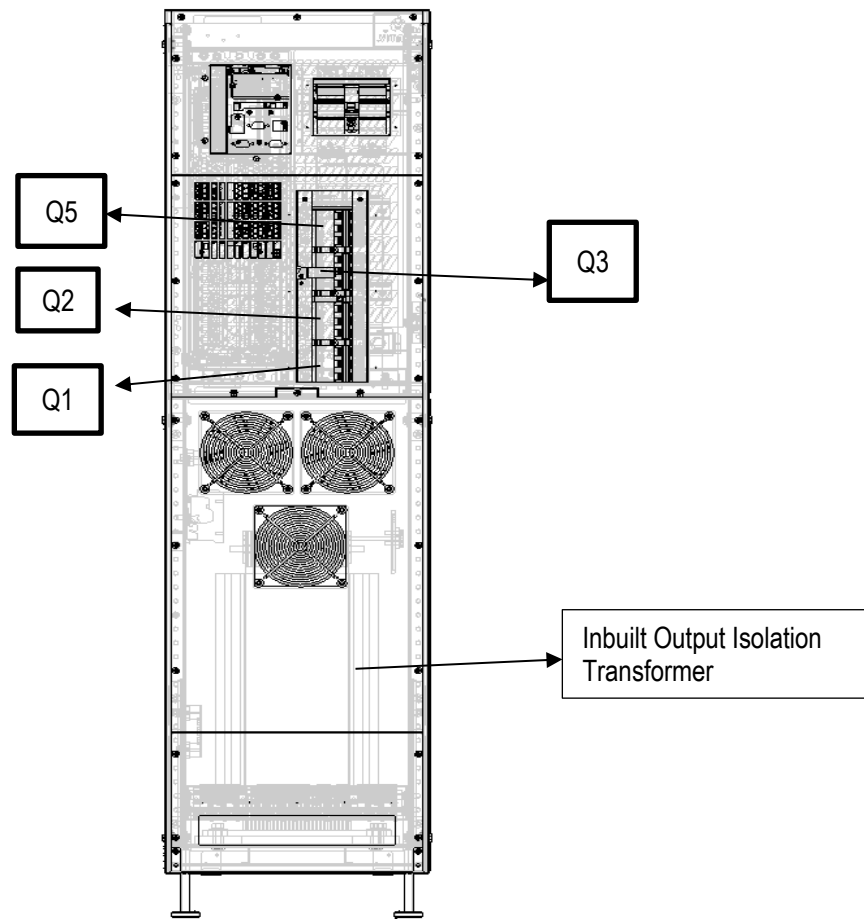

Figure 5-1 UPS power switch

5.2 UPS Start-up Procedures

5.2.1 Check Before Start-Up

1. Check and confirm that the UPS and POD power distribution mode (if configured) is correct, that the power and signal cables are connected correctly, and there are no short circuits.
2. Check that the batteries have been installed properly, the cable have been connected correctly, and that the positive and negative battery poles are correct.
3. Measure the mains voltage and frequency, and verify that they are correct.
4. The UPS and POD (if configured) output terminals are energised when the UPS is switched on. If the load is already connected to the output terminals, make sure that it is safe to apply power to it.

5.2.2 Start-up Interface

The first time the system is started up, mains input mode only may be used, and the LCD screen will display the start-up interface, see Figure 5-2.



Figure 5-2 Start-up interface

5.2.3 Start-up Procedures In Normal Mode



Warning

1. These procedures result in mains voltage being applied to the UPS output terminals.
2. If any loads are connected to the UPS output terminals, check with the user that it is safe to apply power. If the load is not ready to receive power, please disconnect the downstream load switch, and apply a warning label at the load connection point.

Use the following procedures to switch the UPS on when it is in the fully switched off state.

1. Ensure that the internal maintenance bypass switch Q3 is off, and that the input cables and PE terminals are connected securely.
2. Close the UPS bypass input switch Q2, rectifier input switch Q1, output switch Q5 and all external output isolating switches (if any) in that order. The rectifier runs in normal state for about 30 seconds, after which the rectifier start-up phase is complete.
3. Finish setting up the single UPS parameters and check them.

a) Access the main menu screen, press the  or  key to select 'Settings', and press the  key to access the interface shown in Figure 5-3.

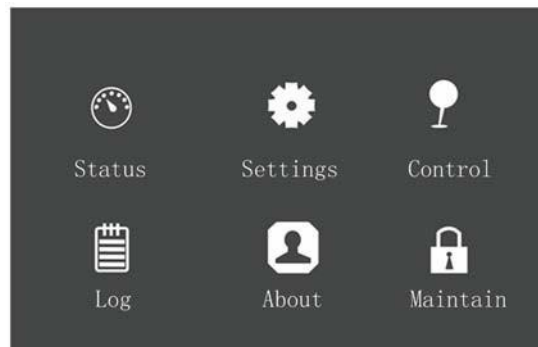

Figure 5-3 Main menu screen

b) Press the  or  key to select and set-up corresponding parameters (taking 'Output' as an example). As shown in Figure 5-4.



Figure 5-4 Output interface

- After setting up the corresponding parameters, press the power button for two seconds so that the dialogue box shown in Figure 5-5 appears on the LCD screen.



Figure 5-5 Switching the UPS on

After selecting 'YES', the run indicator (green) blinks, the inverter starts, and the run indicator switches on.

- Measure the inverter output voltage and verify whether it is within normal limits.
- If the battery is not connected, the alarm indicator will be coloured yellow. If the battery is connected, the alarm indicator will be extinguished.

5.2.4 Start-up Procedures In Battery Mode (Battery Cold Start)

- In the case of UPS with internal batteries, simply press the power button on the UPS front panel for two seconds; in the case of UPS with external batteries, close the BCB first, and then press the power button on the UPS front panel for two seconds, at this point the LCD displays the start-up screen. The alarm indicator will be coloured yellow and the buzzer will beep continuously after the rectifier completes the start-up phase.
- Press the power button for two seconds so that the dialogue box shown in Figure 5-6 appears on the LCD screen.



Figure 5-6 Switching the UPS on

After selecting 'YES', the inverter starts, and the run indicator (green) is illuminated.

5.3 Procedures for Transferring Between Operating Modes



Note

The Inverter operating modes include Normal mode and Battery mode.

5.3.1 Transfer from Normal Mode to Battery Mode

When the mains supply is interrupted, the UPS will transfer to Battery mode. If you wish to transfer the UPS from Battery mode to Normal mode, wait few seconds for the mains input to recover. After about ten seconds, the rectifier will restart automatically, and the inverter will restore the power.

5.3.2 Transfer from Normal Mode to Bypass Mode

In stand-by mode, press and hold the power button. If the rectifier and inverter are normal, the interface shown in Figure 5-7 will appear, select 'YES' to switch the UPS on.



Figure 5-7 Switching the UPS on

In Inverter mode, press and hold the power button. If the bypass is normal, the interface shown in Figure 5-8 will appear. Select 'To Bypass' and click OK to transfer the UPS to Bypass mode; select 'Turn off UPS' and click OK to turn switch the UPS off.

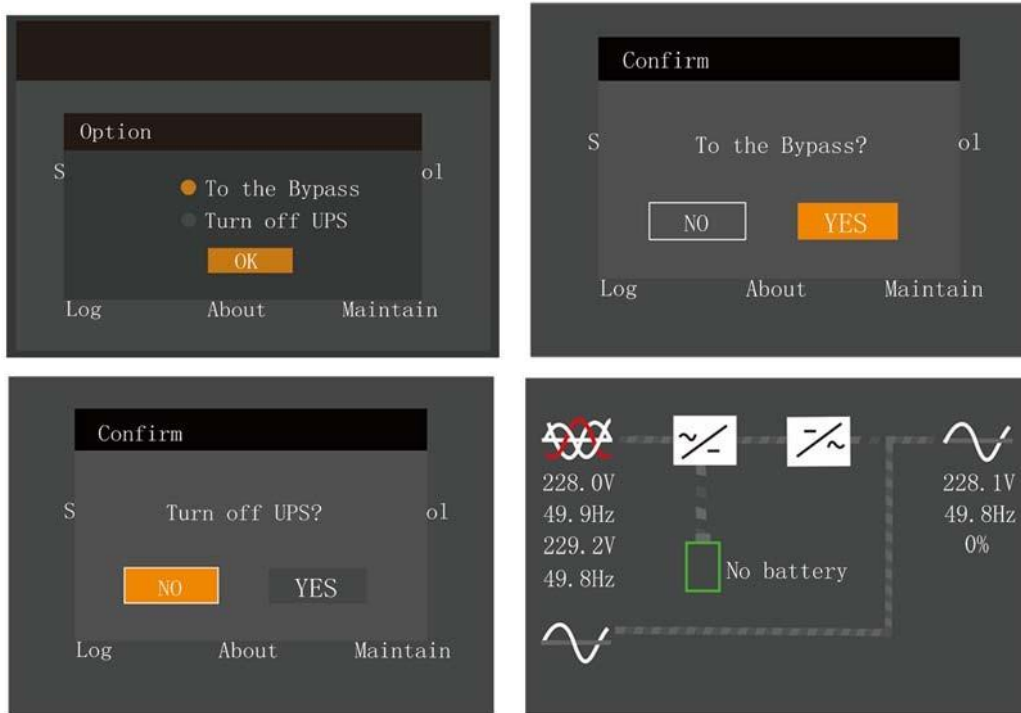

Figure 5-8 Bypass normal interface

In Inverter mode, press and hold the power button. If the bypass is abnormal, then the interface shown in Figure 5-9 will appear, select 'YES' to shut down the UPS output.



Figure 5-9 Bypass abnormal interface



Note

In Bypass mode, the load is directly fed by the mains power instead of the pure AC power from the inverter.

For detailed information about Normal mode, Bypass mode, and Battery and Maintenance Bypass mode, please refer to 1.4 .

5.3.3 Transfer From Bypass Mode To Inverter Mode

In Bypass mode, press and hold the power button.

If ECO mode is not enabled, the interface shown in Figure 5-10 will appear.

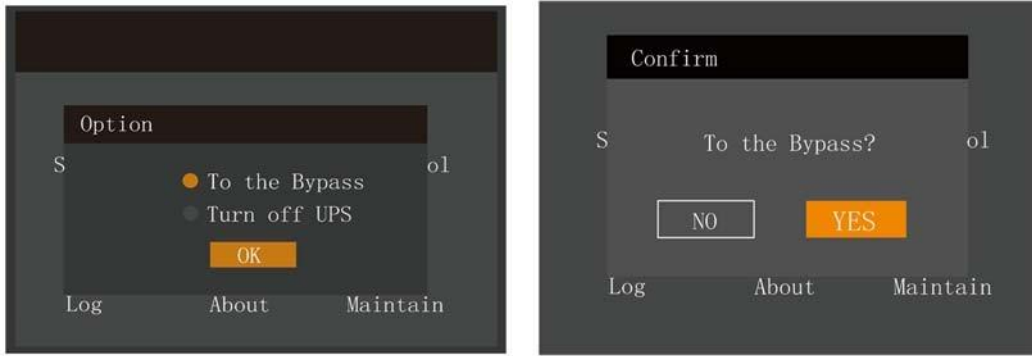

Figure 5-10 ECO mode not enabled

Select 'Turn on UPS' and click OK to transfer to Inverter mode, see Figure 5-11.
 Select 'Turn off UPS' and click OK to shut down the UPS output.

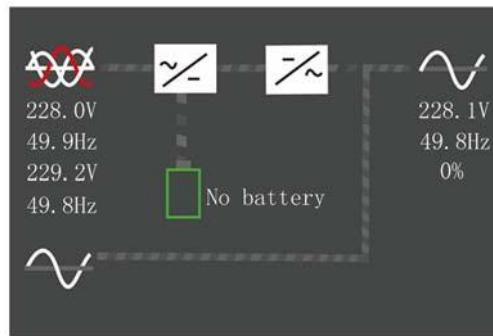

Figure 5-11 Bypass to inverter mode

If ECO mode is enabled, the interface shown in Figure 5-12 will appear. Select 'YES' to shut down the UPS output.



Figure 5-12 ECO enabled interface

5.3.4 Transfer From Normal Mode To Maintenance Bypass Mode

When the UPS is running in Normal mode, you can use this procedure to transfer the load from inverter output to maintenance bypass.



Caution

Before performing this procedure, you should check the LCD information first, and make sure the bypass is normal and synchronized with the inverter. Failure to do so may result in a brief interruption in the power supply to the load.

1. Remove the maintenance bypass switch baffle retaining screws, rotate the baffle upwards until it is locked in position, and then fasten the retaining screws. As shown in Figure 5-13.

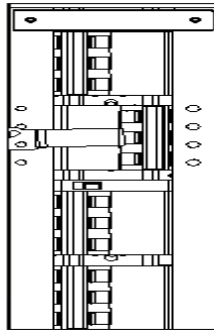

Figure5-13 Moving the baffle upwards

At this point, the system Interlock function has been activated and the UPS will transfer to internal bypass mode; you should confirm that the UPS has been transferred to internal bypass mode.

2. After confirming, close the maintenance bypass switch Q3.
3. Disconnect the output switch Q4.



Caution

When the UPS is in maintenance bypass mode, the load is not protected against abnormalities in the mains power supply.

4. Unplugging the REPO terminal deactivates the rectifier, inverter, static switch and battery, but does not affect the maintenance bypass power supply to the load.



Note

In maintenance mode, the load is fed directly by the mains power instead, of the pure AC power from the inverter.

5. Disconnect the rectifier input switch Q1 and bypass input switch Q2. At this point, all the internal power supplies are deactivated and the LCD screen is switched off.
6. If the UPS is equipped with internal batteries, make sure that they have been isolated from the UPS before carrying out maintenance work on it. Refer to 6.10 for details.

5.3.5 Transfer From Maintenance Bypass Mode To Normal Mode

Following UPS maintenance operations, the following procedures may be used to transfer the load from the maintenance bypass to the inverter.

1. If the UPS is equipped with internal batteries, simply connect the UPS and internal batteries when you finish servicing the UPS. Refer to 6.10 for details.
2. Close the output switch Q4.
3. Close the bypass input switch Q2.
4. Following the LCD start-up, ensure that the system is operating in Bypass mode.



Warning



It is important to close the bypass switch (Q2) before opening the maintenance bypass switch; otherwise the power supply to the load will be interrupted.

5. Set internal maintenance bypass switch Q3 to off. Return the Q3 baffle to its original position, then fasten the retaining screws.
6. Close the rectifier input switch Q1, wait for the rectifier to start-up.
7. Press the power button on the operator and display panel of the UP so that the UPS transfers to Inverter mode.

At this point, the load has transferred to UPS normal mode.

5.4 UPS Shut-down Procedures

5.4.1 Procedures For Completely Powering Down the UPS

In order to shut the UPS down completely and disconnect the power supply to the load, proceed as follows: All power switches, isolating switches and breakers are switched to off, and the UPS no longer supplies power to the load.



Caution

The following procedures will interrupt the power supply to the load, switching it off.

1. Press the power button on the display panel, the UPS will transfer to Bypass mode.
2. Unplug the REPO terminal at rear of the UPS to deactivate the rectifier, inverter, static switch and battery.
3. If the UPS is equipped with an external battery, set the corresponding external battery switch to off.
4. Set the rectifier input switch Q1 and bypass input switch Q5 to off. At this point, all the internal power supplies are deactivated and the LCD screen is switched off.



Warning

1. Post a label on the AC input distribution line (generally at a distance from the UPS) to alert personnel that UPS maintenance is in progress.
2. Wait 10 minutes for the internal DC bus capacitors to discharge. Then the UPS is completely shut down.



Warning: hazardous battery voltage

Hazardous voltages are still present on the battery terminals, even after the UPS has been shut down.



Warning

Neutral not disconnected. Parts of the equipment might remain energized, representing a hazard during servicing.

5.4.2 Procedures Shutting Down the UPS Completely While Maintaining Power To Load

The following procedures may be used to shut the UPS down completely are applicable for completely, while maintaining the power supply to the load. Refer to the procedures in 5.3.4 .

5.5 REPO

The REPO port, located at rear of the UPS, is designed to switch off the UPS in the event of an emergency (such as fire, flood). After unplugging the REPO terminal, the system will switch off the rectifier and inverter, and interrupt the power supply to the load immediately (inverter and bypass output included), while the battery will stop charging or discharging.

After EPO, if the mains input is present, the UPS control circuit will remain active; however, the output is interrupted. To completely remove all mains power from the UPS, first disconnect the UPS external mains switches, and then disconnect the battery terminals.

5.6 Automatic Restart

In the event of a mains power failure, the UPS draws power from the battery in order to supply the load until the batteries are discharged, at which point the UPS will shut down.

The UPS will restart automatically and resume supplying power to the load:



- Once the mains power supply is restored.
- If the UPS Auto Restart function is enabled.
- After the Auto Restart delay has expired (default: 10s). During the Auto Restart delay, the UPS will charge the battery in order to provide a safety margin for equipment shut-down if input power fails again.

If the Auto Restart function is disabled, you can restart the UPS manually by pressing the power button.

5.7 Language Selection

The LCD menus are available in two languages: Chinese, English.

Language selection procedure:

1. Access the main menu screen and press the  or  key to switch the cursor to select 'Settings', then press the  key to confirm. See Figure 5-14.

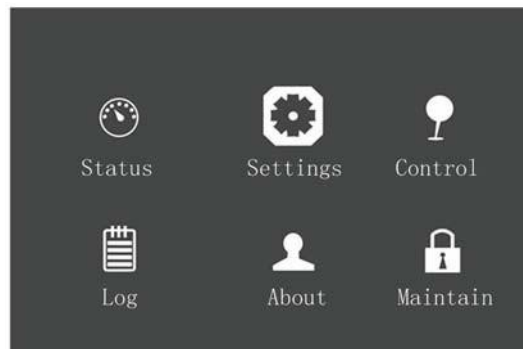



Figure 5-14 Main menu

2. Press the  key to move the cursor to 'Monitor', see Figure 5-15.

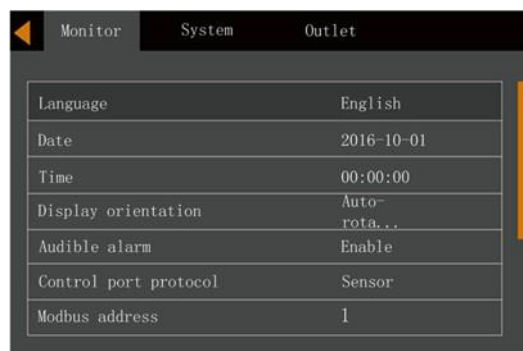



Figure 5-15 Monitor interface

3. Press the  key to highlight the language, see Figure 5-16.

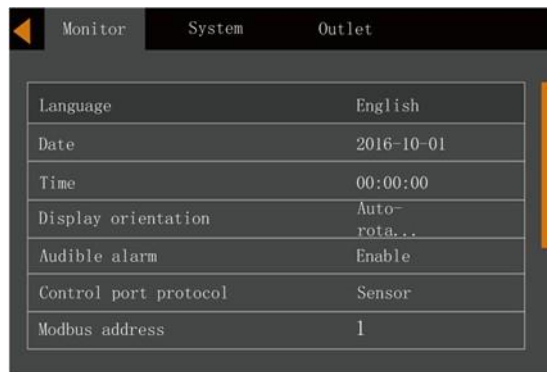

Figure 5-16 Language selection

4. Press the or key to select your required language, then press the key to confirm. At this point the LCD information will be displayed in your selected language. See Figure 5-17.

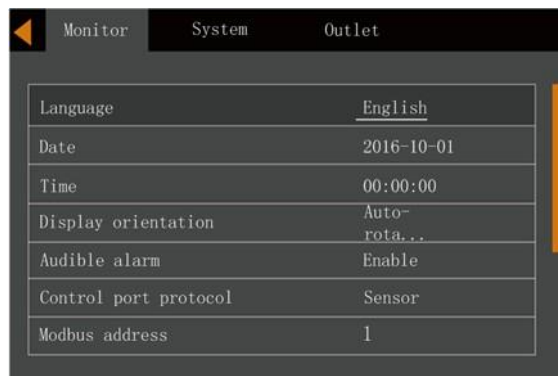

Figure 5-17 Changing Language

5. Press the key several times to return to the main menu screen.

5.8 Changing the Current Date And Time

Procedures for changing the system date and time:

1. Access the main menu screen and press the or key to switch the cursor to select 'Settings', then press the key to confirm. See Figure 5-18.

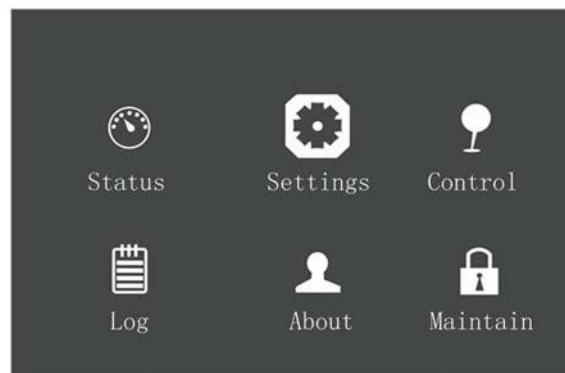

Figure 5-18 Main menu screen

2. Press the key to move the cursor to 'Monitor', see Figure 5-19.

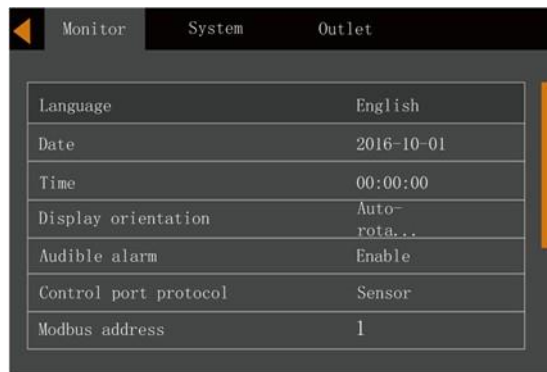

Figure 5-19 Monitor interface

3. Press the **Enter** key, followed by the **▲** or **▼** key to highlight the date and time, see Figure 5-20.

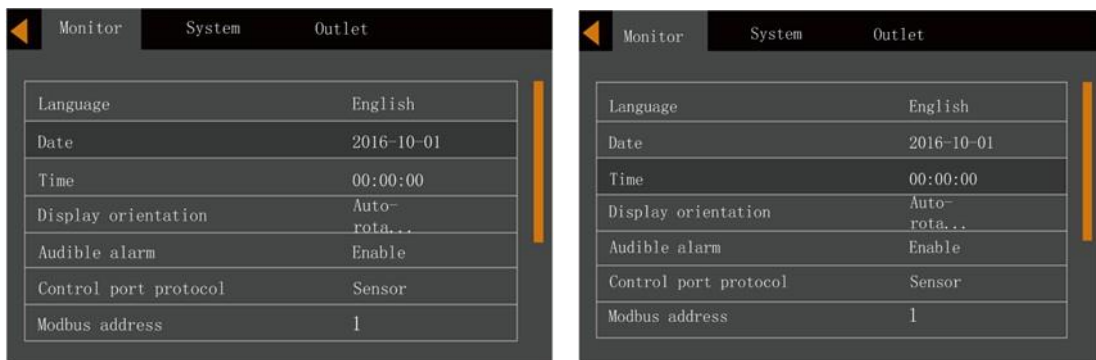

Figure 5-20 Selecting date and time

4. Press the **Enter** key, move the cursor and press the **▲** or **▼** key to change the date and time as required. See Figure 5-21.

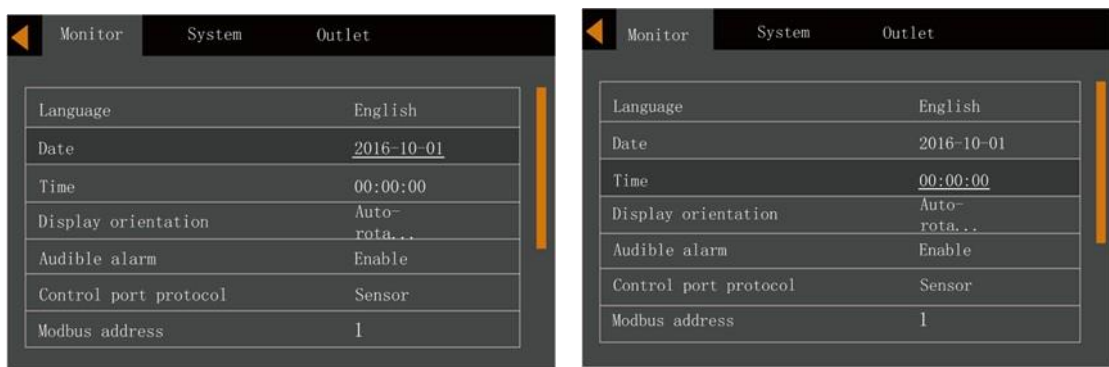

Figure 5-21 Changing date and time

5. Press the **Enter** key to confirm, and then press the **Esc** key several times to return to the main menu screen.

5.9 Setting the Password

1. After switching the UPS on, access the main menu screen and press the **▲** or **▼** key to move the cursor to select 'Settings'. See Figure 5-22.

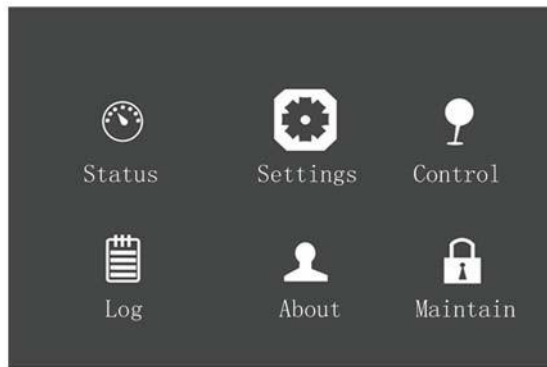

Figure 5-22 Main menu



2. Press the  key, the interface shown in Figure 5-23 will appear.



Figure 5-23 Entering the password

To change the password, proceed as follows:

1. Press the  key to move the cursor to the 'Monitor' page, see Figure 5-24.

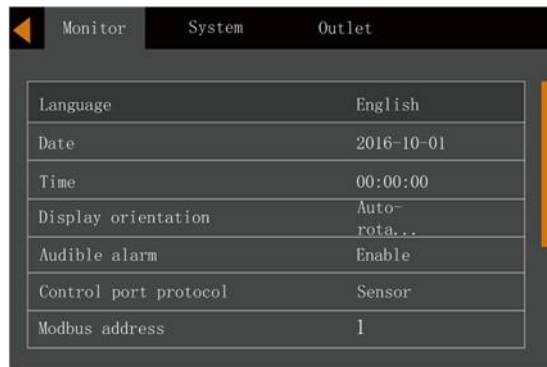



Figure 5-24 Monitor interface

2. Press the  key, then press the  key to select 'Change settings password', see Figure 5-25.

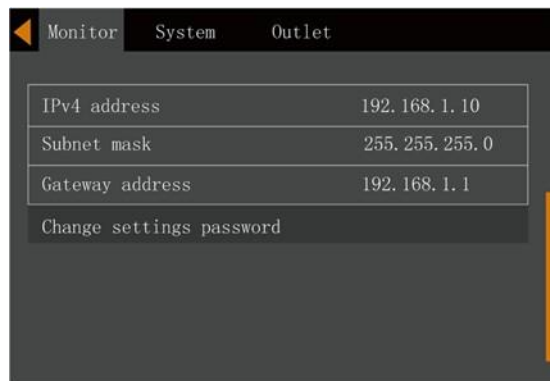



Figure 5-25 Changing the settings password

3. Press the  key, the interface shown in Figure 5-26 will appear.

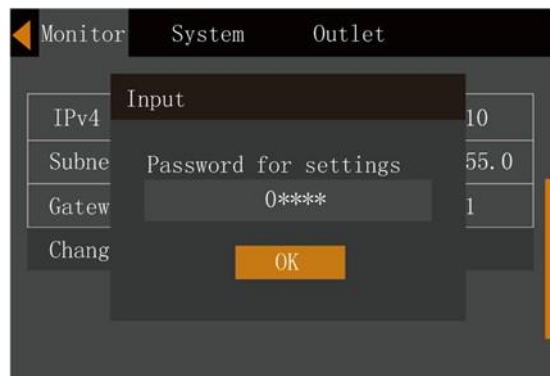

Figure 5-26 Settings password



4. Enter the current password and press the  key to confirm; at this point requests the user to enter a new password. See Figure 5-27.



Figure 5-27 Entering the new password

5. After entering the new password, press the  key to confirm; at this point the system requests the user to confirm the new password by entering it again, see Figure 5-28.

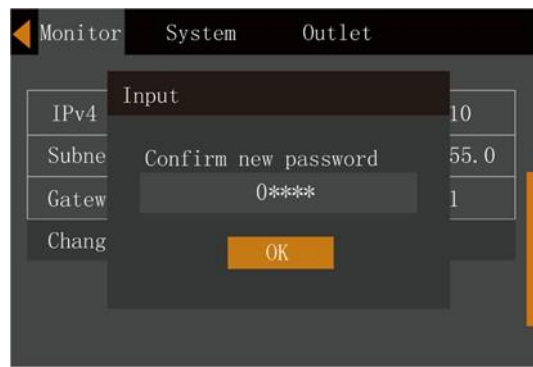



Figure 5-28 Confirming the new password

6. After the confirming the new password, press the  key; at this point a system prompt appears indicating that the password has been changed successfully, see Figure 5-29.

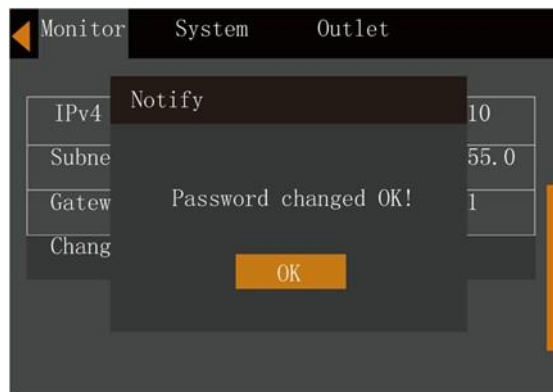



Figure 5-29 Password changed successfully

7. Press the  key several times to return to the main menu screen.



Note

In order to access the UPS parameters it is necessary to enter the correct password (default:111111)

Chapter 6 Battery

This section introduces the battery, providing information about safety, installation and maintenance, and the battery protection function.

6.1 Introduction

The UPS battery string consists of a number of batteries connected in series, and provides rated DC input voltage for the UPS inverter. The required battery backup time (i.e. The length of time the battery is able to supply the load for following a mains failure) depends on the ampere-hour value of the battery. Under certain conditions, it may be necessary to connect several battery strings in parallel.

For ease of installation, the battery is generally placed in the specially designed battery rack or a dedicated battery room.

During the maintenance or repair, the battery must be disconnected from the UPS. This may be achieved by using a suitably rated battery circuit breaker. This circuit breaker must be located as close as possible to the battery connection terminals, while the length of the power and signal cables connected to the UPS must be kept to a minimum.

When several battery strings are connected in parallel in order to increase the battery backup time, each string must be fitted with its own disconnecting device, so that, when it is necessary to carry out maintenance work on an individual battery string, the normal operation of the other strings is not affected.

6.2 Safety

Take special care when working with the batteries associated with this UPS. When all the blocks are connected, the battery string voltage can reach 540Vdc. This is potentially lethal. Please follow the precautions for working with high voltages.



Only qualified personnel may install and service the battery. To ensure safety, the external batteries must be installed inside a lockable cabinet or in a purpose-designed, dedicated battery room, so that they are only accessible to qualified service personnel.

Confirm that the battery switch has been set to off before carrying out battery maintenance operations.





Warning: hazardous battery voltage present behind covers

1. No user-serviceable parts are located behind the protective covers that can only be removed by using tools. Only qualified service personnel are authorized to remove such covers.
2. Before working on the copper bars connected to the external battery, please ensure they are disconnected from all power supplies.

Proper connection mode	Improper connection mode	
Tighten the terminal bolt of the battery, applying the specified torque	Applying too little or too much torque may result in poor connections. Under certain conditions, the terminal may be subject to arcing or heat accumulation, which can result in fire	
		

3. Observe the following safety precautions when working on the batteries:
 - a) The batteries must be firmly and securely connected. After the connection is completed, the screw connections between all the terminals and the batteries shall be calibrated. The torque requirements indicated in the specifications or user manual provided by the battery manufacturer must be respected. The connections between all the wiring terminals and the batteries shall be inspected and tightened at least once a year. Failure to do so may result in fire!
 - b) Visually inspect the batteries before accepting and/or using them. If the packaging is damaged, the terminals are dirty, eroded or rusty, or if the cases are cracked, deformed or leaky, replace the battery with a new one. Failure to do so may result in reduced battery capacity, leakage of electrolyte or even fires.

Battery damaged during handling or shipping	After a week of normal charge/discharge cycle testing
	

- c) Batteries are very heavy. Please use the proper procedures when moving and lifting batteries in order to prevent injury and avoid damaging battery terminals. Severe damage to the battery may cause fire.
- d) The battery connecting terminal must not be subject to any force, such as pulling twisting forces exerted by the cables, otherwise, the internal battery connections may be damaged. Severe damage to the battery may cause fire.
- e) The battery must be installed and stored in a clean, cool and dry environment. Do not install the battery in a sealed battery chamber or a sealed room. The battery room ventilation shall at least meet the requirement of EN50272-2001. Otherwise, battery bulging, fire or even human injury may be caused.
- f) Batteries must be installed away from heat sources (e.g. Transformers) and kept away from sources of fire, in addition, they must not be burnt or heated in a fire. Otherwise, battery leakage, bulging, fire or explosion may be caused.
- g) Do not connect conductors directly between the positive and negative terminals of the battery. Remove the rings, watches, necklaces, bracelets and other metal items before working on batteries, and always used insulated tools (e.g. wrenches). Otherwise, battery burning, human death/injury or explosion may be caused.
- h) Do not attempt to disassemble, modify or demolish batteries. Otherwise, battery short circuit, liquid leakage or even human injury



Warning: hazardous battery voltage present behind covers

may be caused.

i) Clean the battery enclosure with a damp cloth. To avoid any static or arcing, do not use dry cloths or dusters to clean the batteries. Do not use the organic solvents (such as thinners, gasoline, volatile oil) to clean the batteries. Otherwise, the battery enclosure may be cracked. In the worst case this may even result in fires.

j) The batteries contain diluted sulphuric acid. In normal use, the diluted sulphuric acid will be absorbed by the battery baffle and polar plate. However, if the battery is damaged, it may leak acid. Therefore, personal protective equipment (e.g., protective glasses, rubber gloves and apron) must be used when working with batteries. Failure to observe the above may result in blindness, if the sulphuric acid comes into contact with the eyes, or burns, if it comes into contact with the skin.

k) batteries may be affected by short circuits, electrolyte dry-up or positive pole erosion failure at the end of their service life. Continued use in this state may result in thermal runaway, bulging or liquid leakage. Please replace the batteries before they reach this state.

l) Before connecting or disconnecting the battery connection cables, please isolate them from the battery charger terminals.

m) Check whether the battery has been unexpectedly earthed. If so, remove the earth connection. Contact with any part of the earthed battery may result in an electric shock.

6.3 UPS Battery

The UPS is normally equipped with valve-regulated batteries. The term 'valve-regulated' replaces the 'sealed type' or 'maintenance free', which were used in the past.

Valve-regulated batteries are not completely sealed, therefore some gas will be expelled especially when they are over-charged. The volume of expelled gas is less than that for water injection type batteries. However, when designing the battery installation area, it is important to take the possibility of temperature rise into account and ensure there is sufficient space to ensure good ventilation.

Additionally, it is worth noting that valve-regulated batteries are not entirely maintenance free. In fact, they must be kept clean, and inspected regularly to check if the connection is secure and the terminals are free from corrosion. For details, please refer to 6.9 .

We recommend that you do not connect more than 4 strings of batteries in parallel. All batteries in the same system must be of the same type, brand, capacity and age. Failure to observe this condition will result in regular over/under charging of certain batteries within the string. This will eventually lead to premature failure, compromising the back-up time of the affected string.

The battery must be stored in fully charged state. The battery will lose a certain proportion of its capacity due to self-discharge during the shipping or storage. Charge the battery before use. During storage, ensure that the ambient temperature remains within between -15°C and +45°C; the optimal temperature range is between 20°C and 25°C. To compensate for the self-discharge, recharge the battery once every 3 months during while it remains in storage. This period may differ, depending on the specific batteries. For details, refer to the battery manufacturer's specifications.

It is important to ensure the battery is fully charged before carrying out the on site battery backup time test. This test may take several days. Therefore, it should be conducted after the battery has been subject to uninterrupted float charging for at least one week.

The battery performance will gradually increase after it has been running for several weeks or subject to two to three charge and discharge cycles.

To avoid over/under-charging the battery, please set-up the battery management parameters according to the equalizing/float charge voltage and temperature compensation factor specified in the manuals provided by the battery manufacturer. Please charge the battery immediately after it has been discharged.

6.4 Precautions For Installation Design



Note

1. The precautions that must be applied when installing, using and servicing the batteries are described in the respective battery manual provided by the battery manufacturer.
2. The safety precautions described in this section include important matters that must be taken into account when designing the installation.
3. The design results may vary according to the local situation.

6.5 Battery Installation Environment and Number of Batteries

6.5.1 Installation Environment

Fresh air volume (EN50272-2001)

The battery operating environment must be well ventilated. During battery operation, the following fresh air ventilation requirement must be satisfied:

$$Q=0.05 \times n \times I_{\text{gas}} \times C_{\text{rt}} \times 10^{-3}[\text{m}^3/\text{h}]$$

Where:

Q = The fresh air ventilation volume per hour, the unit is m³/h

N = Number of cells

I_{gas} = The gas evolving current density under battery float charging or boost charge conditions, the unit is mA/Ah

I_{gas}=1, under the float charging condition of 2.27V/cell

I_{gas}=8, under the float charging condition of 2.35V/cell

C_{rt} = 20hr battery rated capacity

Temperature

Table 6-1 Ambient temperature range

Type	Temperature value	Note
Recommended optimal temperature	20°C - 25°C	The ambient temperature for the battery operation must not be too high or too low.
Short time allowable temperature	-15°C - 45°C	If the average operating temperature of the battery rises from 25°C to 35°C, the service life of the battery will be reduced by 50%. If the operating temperature of the battery exceeds 40°C, the service life of the battery will be reduced exponentially each day

The higher the temperature, the shorter the battery service life. At low temperatures, the charge/discharge performance of the battery will be significantly reduced.

The battery must be installed in a cool and dry environment where the relative humidity is less than 90%, and must be protected from heat sources and direct sunlight.

The ambient temperature, ventilation, space, float/boost charge voltage and ripple current will all affect the battery temperature. Uneven temperature among the battery strings will cause uneven voltage distribution and thus compromise performance. Therefore, it is very important to maintain a balanced temperature along the entire length of the battery string, and to ensure that the temperature difference between batteries on different layers does not exceed 3°C. Valve-regulated batteries are very sensitive to the temperature, therefore the working temperature should be maintained between 15°C and 25°C. If the battery cabinet is installed near the UPS, the maximum design ambient temperature shall be determined according to the battery rather than the UPS. This means that, if valve-regulated batteries are used, the indoor ambient temperature shall be 15°C - 25°C rather than the operating temperature range of the UPS modules. Provided the average temperature remains below 25°C, brief excursions in excess of this value are permitted.

6.5.2 Number Of Batteries

The number of batteries, EOD voltage, and float charging voltage must be consistent with the voltage selection (220V/230V/240V), as shown in Table 6-2.

Table 6-2 Number of batteries

Parameter	220V/230V/240V
Number of cells (standard)	192, 240
EOD voltage	1.60Vdc/Cell - 1.85Vdc/Cell, 1.62V/cell recommended
Float charging voltage	2.2Vdc/Cell - 2.3Vdc/Cell, 2.27V/cell recommended

6.6 Battery Protection

If internal batteries are selected, the UPS is equipped with an internal fused switch designed to protect the internal battery. If external batteries are selected, please select a BCB with sufficient DC breaking capacity.



Important

To avoid risks, we recommend using a VERTIV BCB for your external battery.

The external battery must be connected to the UPS via the BCB. The BCB can be closed manually and is equipped with an electronic tripping device controlled by the UPS control circuit. In the case of rack-mounted batteries (or batteries that are installed at a distance from the UPS cabinet), the BCB must be installed as close to the battery as possible, and the length of the power and signal cables connected to the UPS must be kept to minimum.

The UPS provides the following advantages:

- Safe, reliable battery isolation
- Short circuit protection
- If the inverter is locked because of battery under-voltage, the circuit breaker will be opened
- automatically in order to avoid over-discharging the battery.
- If the remote EPO button is installed, the EPO button can be used to open the circuit breaker
- Protection against misuse

To obtain the required backup time, the batteries may be connected in parallel. In this case, the BCB must be installed downstream of the battery parallel connection point.



Note

Only trained personnel may operate and service the battery circuit breaker.

6.7 Battery Installation and Connections

6.7.1 Battery Installation

1. Before installation, check the batteries for damage, inspect and count the accessories, and carefully read this manual and the user manual or installation instructions provided by the battery manufacturer.
2. There must be a vertical gap of at least 10 mm between the batteries in order to ensure the free circulation of the ambient air between the batteries.
3. A certain amount of clearance shall be maintained between the top of the batteries and the next layer in order to facilitate battery monitoring and service operations.
4. Install the batteries starting from the bottom layer and working upwards, in order to avoid creating a high centre of gravity. The battery shall be properly installed and protected against vibration and/or impacts.

6.7.2 Battery Connections

1. All the battery cabinets or battery racks must be connected and properly grounded.
2. When multiple battery strings are used, they shall be connected first in series and then in parallel. Before switching the UPS on and connecting it to the load, check that the total voltage of the batteries is as specified. The negative and positive poles of the batteries must be connected to the negative and positive battery terminals of the UPS, in accordance with the labels on the battery and UPS. If the battery connections are inverted it can cause fires or explosions, and may result in battery and UPS damage or even human injury.
3. When the battery cable connection procedure is complete, install insulating shields on the terminals.
4. When connecting the cable between battery terminal and BCB, the BCB terminal must be connected first.
5. The bending radius of the cable shall be larger than 10D, wherein D is the outer diameter of the cable.
6. When the battery cable is connected, it is prohibited to pull on the battery cable or the cable terminal.
7. Do not cross the battery cables when connecting them, and do not tie the battery cables together.
8. See 8.2.1 *Internal Battery Kit* for details about the battery connections.

6.8 Designing the Battery Room

Irrespective of the type of installation system that is adopted, it is important to pay particular attention to the following items (refer to Figure 6-1):

① Layout of cells

Irrespective of the type of installation system that is adopted, the batteries must be positioned so that no two parts having a potential difference of greater than 150 V can come into contact with each other at any time. If this is unavoidable, insulated terminal shields and insulated cables shall be used for the respective connections.

② Workbench

The workbench (or platform) must be skid-proof and insulated, and at least 1m wide.

③ Wiring

All the wiring distances shall be kept to a minimum.

④ BCB

The BCB is normally installed in a wall-mounted box close to the battery.

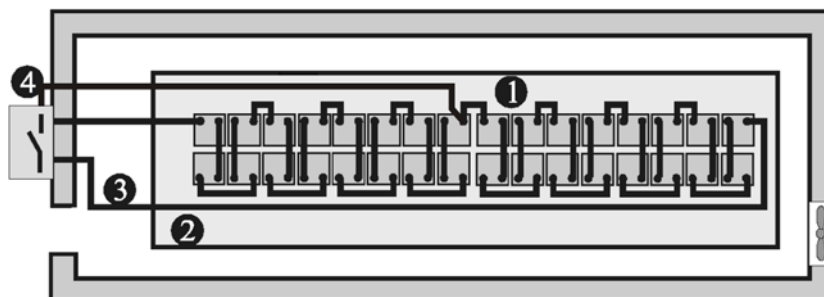

Figure 6-1 Design of battery room

6.9 Battery Maintenance

For the battery maintenance and maintenance precautions, refer to IEEE-Std-1188-2005 and the relevant manuals provided by the battery manufacturer.



Note

1. Check the battery connection screws at regular intervals. If any loose screws are found, re-tighten them immediately.

2. Make sure that all the safety devices are present, in good condition and that they function correctly, and make sure that the battery management parameter settings are correct
3. Measure and log the air temperature in the battery room.
4. Check to the battery terminals for damage or signs of heating, and that the battery enclosure and terminal shields are intact.

For details, refer to 9.2 .

6.10 Disconnecting or Connecting Internal Battery Terminals



Warning

1. If you need to service the UPS, please be sure to disconnect cable connections between the UPS and batteries. Failure to observe this condition may result in electric shock or battery arc risk.
2. Batteries may only be service by qualified personnel and the appropriate protective equipment and clothing must be used at all times.

When the UPS has been fully shut down, if it is equipped with internal batteries the internal battery terminals will remain live because there is no switch between the UPS and its internal batteries.

Use the appropriate tools to open the front cover of the battery compartment, and then disconnect the connection between the UPS and its internal batteries. Refer to Figure 8-1 and Figure 8-3 for details. Wear arc protective gloves and arc protective clothing when disconnecting the cabinet battery terminals and internal battery terminals. To disconnect the internal batteries in the standard UPS, simply open the connection terminals between W101 and W107, W102 and W106, W103 and W108; to disconnect the internal batteries in the UPS with side cabinet, simply open the connection terminals between W101 and W107, W102 and W106, W103 and W108 first, and then open the connection terminals between W201 and W207, W202 and W206, W203 and W208. Refer to Figure 6-2 for instructions on disconnecting the terminals.



Once the above operations are complete, the UPS is no longer connected to its internal batteries. At this point it is safe to carry out maintenance work on the UPS since the battery terminals are completely de-energized.

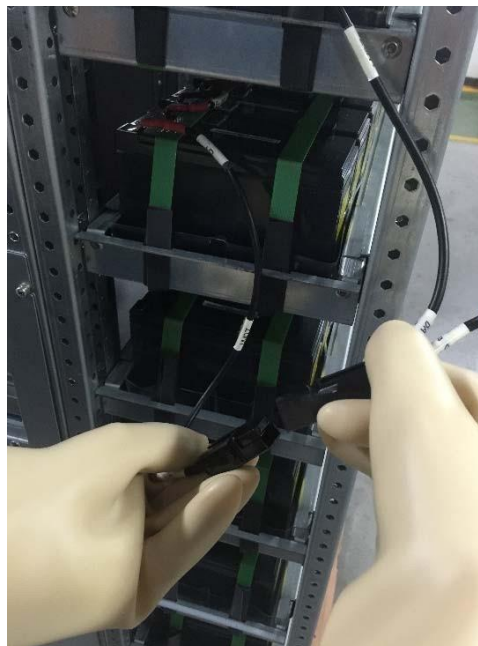

Figure 6-2 Schematic diagram for disconnecting internal battery terminals

Once the maintenance work is complete, please wear arc protective gloves and arc protective clothing when reconnecting the cabinet battery terminals and internal battery terminals. To reconnect the internal batteries in the standard UPS, simply restore the connection terminals between W101 and W107, W102 and W106, W103 and W108; to reconnect the internal batteries in the UPS with side cabinet, simply restore the connection terminals between W101 and W107, W102 and W106, W103 and W108 first, and then the connection terminals between W201 and W207, W202 and W206, W203 and W208.

Use a multimeter to check and ensure that the cabinet internal battery terminal poles are correct. Finally, replace the front cover of battery compartment.



Warning

1. If maintenance is required, wait 10 minutes for the internal DC bus capacitors to discharge.
2. Hazardous voltages may be present on some parts of the UPS, even when the rectifier input switch, bypass input switch and battery switch are disconnected. Therefore, UPS maintenance should be carried out by qualified personnel only.

6.11 Disposal of Used Batteries

If any of the batteries are found to be leaking, place them in a suitable container that can withstand sulphuric acid and dispose of them in accordance with local regulations.

Lead-acid batteries are classified as hazardous waste material and represent a key item in the control of battery pollution control. Batteries must be stored, transported, used and disposed of in accordance with national and local legal requirements and all other criteria applicable to the treatment of hazardous waste material and waste battery pollution prevention.

According to the applicable regulations, waste lead-acid batteries must be recycled, while all other disposal methods are prohibited. Uncontrolled or random disposal of waste lead-acid batteries, or other improper disposal methods can result in serious environmental pollution, which will be investigated by the relevant authorities.

Chapter 7 Parallel System and LBS System

This section provides information about installing parallel and LBS systems.

7.1 General

The parallel system may include up to four UPS modules of the same power rating and connected in parallel, without the need for a centralized mains static bypass device. The bypass static switches of the individual UPS modules share the load when the system transfers to the mains bypass supply.

From a 'power' viewpoint, each module is internally identical to the 'single module' configuration. A parallel system requires inter-module control signals to manage load sharing, synchronizing and bypass switching. The control signals are connected by means of the parallel cables, which are multi-way ribbon cables connected between the units of the system to form a ring.

7.2 System Installation Procedures

The basic installation procedure of a parallel system consisting two or more UPS modules is the same as that for a single module system. This section only covers the installation procedures that are specific to the parallel system. When installing a parallel UPS system, follow the installation procedures for a single UPS module, with the additional requirements detailed in this section.

7.2.1 Preliminary Checks

Make sure that correct parallel cable option has been selected, and that the module ratings, model, and software and hardware releases are consistent.



Warning

To achieve coordinated operation of the modules in the parallel system, each module must be configured separately using the VERTIV setting software. This must be done by VERTIV service personnel.

7.2.2 Cabinet Installation

Place the UPS modules side by side and interconnect them as shown in Figure 7-1. The output distribution mode (Q1EXT, Q2EXT must be configured) shown in Figure 7-1 is recommended to facilitate maintenance and system testing.

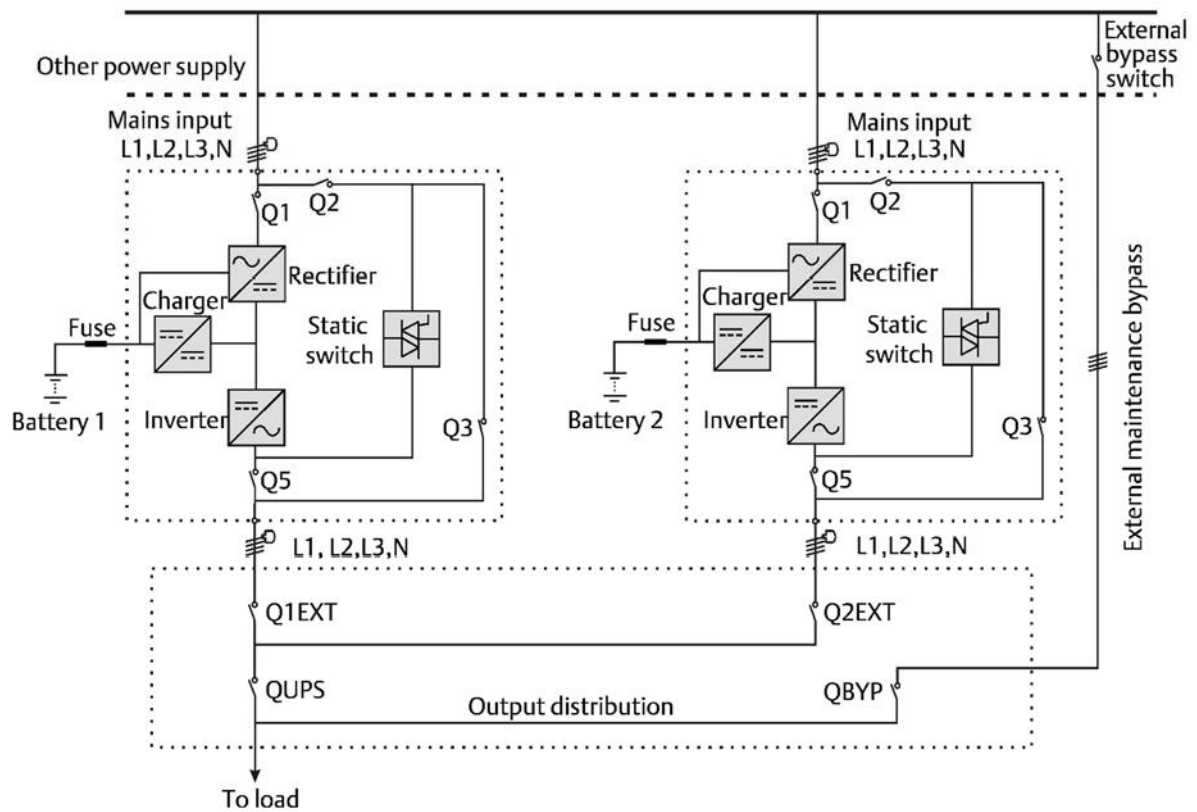

Figure 7-1 Circuit diagram of typical parallel system (with common input, separate batteries and output)

7.2.3 Power Cables

The power cable wiring is similar to that of the UPS module. Refer to 3.1 .

The bypass and rectifier input supplies must use the same neutral line input terminal. If the input is fitted with a current leakage protection device, the device must be fitted upstream of the neutral line input terminal.



Note

The power cables (including the bypass input cables and UPS output cables) of each UPS module should be of the same length and specifications to facilitate load sharing.

7.2.4 Parallel cables

Shielded and double-insulated parallel cables must be interconnected in a ring configuration between the UPS modules, as shown in Figure 7-2. Method: connect a parallel cable between the PARA1 port on one module and the PARA2 port on the next module. Repeat this step for all the other parallel cables.

The ring connection ensures the reliability of the control of the parallel system. Be sure to verify that the cables are connected securely before starting up the system!

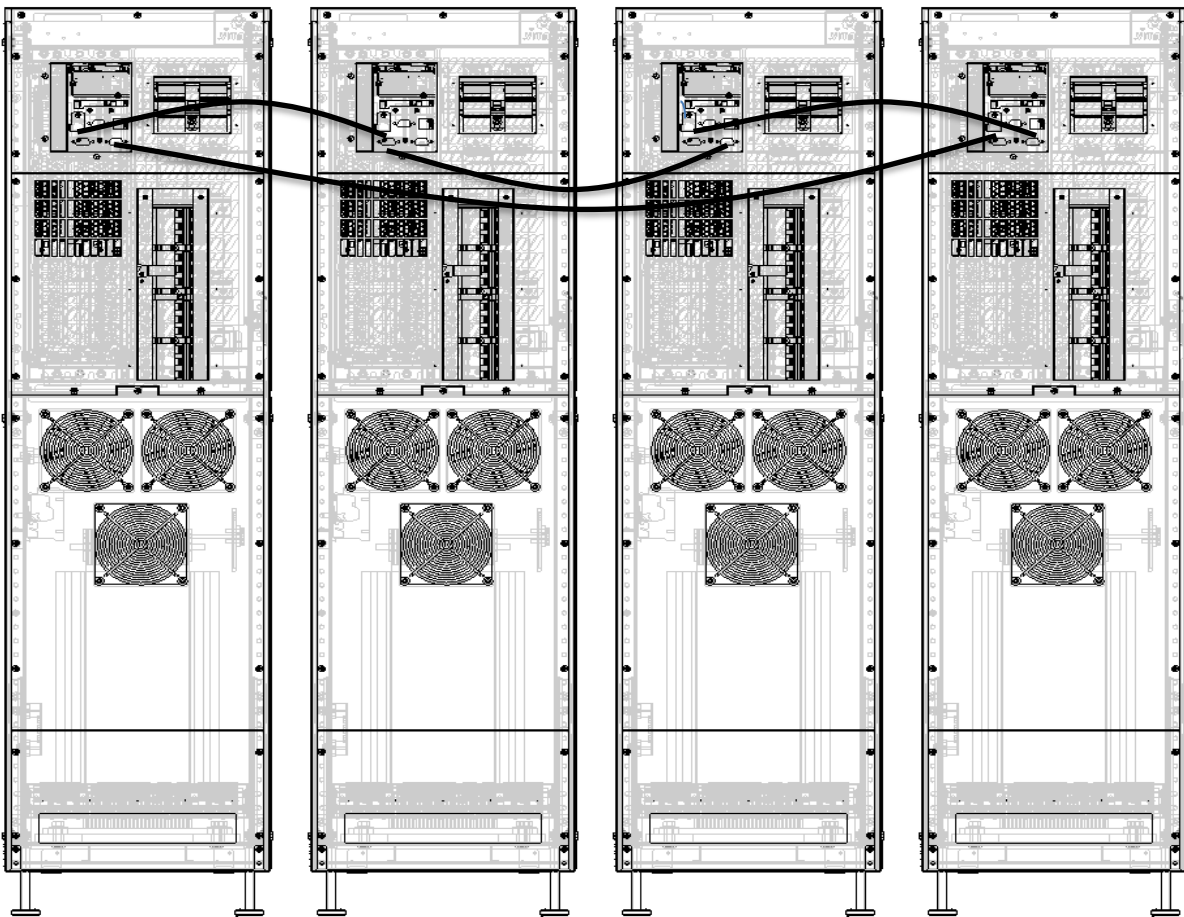

Figure 7-2 Parallel signal cable connections (Parallel system)



Note

1. VERTIV parallel cables must be used for the parallel system.
2. If a parallel communication fault occurs during parallel commissioning or operation, switch the system off and check whether the parallel cables are connected correctly.
3. Do not attempt to disconnect the parallel cables while the parallel system is operating as this could damage the system.

7.3 Operating Procedures for Parallel Systems



Warning

If UPS the input uses RCD devices, the differential switch should only be used on the system bypass mains supply. At the moment of electrical connection, current may not be immediately separated, which may cause the respective RCCB devices to trip.

Proceed one step at a time, and only move on to the next time when the current operation has been completed for all the UPS modules in the system.

7.3.1 Start-up Procedures In Normal Mode

These procedures are used to start the UPS starting from the fully switched off condition, which means that neither the UPS or the maintenance bypass switch have supplied power to the load before. Make sure UPS has been completely installed and commissioned by the engineer, and the external power supply switch is in the off position



Warning

1. These procedures result in mains voltage being applied to the UPS output terminals.
2. If any loads are connected to the UPS output terminals, check with the user that it is safe to apply power. If the load is not ready to receive power, please disconnect the downstream load switch, and apply a warning label at the load connection point.

Use the following procedures to switch the UPS on when it is in the fully switched off state.

1. Confirm that all the external maintenance bypass switches are in the off position. Ensure that the internal maintenance bypass switch Q3 is in the off position, and that the input cables and copper bars and the parallel cables are connected securely.



Warning

To avoid generating spurious fault messages, whenever it is necessary to switch the maintenance bypass switch to the on or off position, the operation must be completed within three seconds.

2. Close all the bypass input switches.
3. Close the UPS bypass input switch Q2, rectifier input switch Q1, output switch Q5 and all external output isolating switches (if any) in that order.

At this point, the system is switched on.

4. Press the UPS power buttons one by one to start the respective inverters.

7.3.2 Operating Procedures in Maintenance Bypass Mode



Warning

If the UPS system consists of more than 2 UPS modules in parallel, and the load capacity exceeds the single module capacity, do not use the internal maintenance bypass switch.

This operation will transfer the load from the UPS power supply protection state to direct connection with AC input bypass state.



Caution: risk of interruption of power supply to load

Before performing this procedure, you should check the LED information first, and make sure the bypass is normal and synchronized with the inverter. Failure to do so may result in a brief interruption in the power supply to the load.

1. Remove the maintenance bypass switch baffle retaining screws, rotate the baffle upwards until it is locked in position, and then fasten the retaining screws. Refer to Figure 5-13.

At this point, the system Interlock function has been activated and the UPS will transfer to internal bypass mode; you should confirm that the UPS has been transferred to internal bypass mode.

2. After confirming, close the maintenance bypass switch Q3.
3. Disconnect the output switch Q5. At this point the load is powered by the maintenance bypass.



Caution

When the UPS is in maintenance bypass mode, the load is not protected against abnormalities in the mains power supply.

4. Unplugging the REPO terminal deactivates the rectifier, inverter, static switch and battery, but does not affect the maintenance bypass power supply to the load.



Note

In maintenance mode, the load is fed directly by the mains power instead, of the pure AC power from the inverter.

5. If the UPS is equipped with an external battery, set the corresponding external battery switch to the off position until all the UPS modules have been disconnected from the batteries.

6. Disconnect the rectifier input switch Q1 and bypass input switch Q2. At this point, all the internal power supplies are deactivated and the LCD screen is switched off.
7. If the UPS is equipped with internal batteries, make sure that they have been isolated from the UPS before carrying out maintenance work on it. Refer to 6.10 for details.



Warning

1. If maintenance is required, wait 10 minutes for the internal DC bus capacitors to discharge.
2. Hazardous voltages may be present on some parts of the UPS, even when the rectifier input switch, bypass input switch and battery switch are disconnected. Therefore, UPS maintenance should be carried out by qualified personnel only.

7.3.3 Procedures for Isolating One UPS Module from a Parallel System



Important

These procedures may only be carried out by VERTIV service personnel, or under their supervision.



Warning

Before operation, confirm that the system capacity has sufficient redundancy to avoid system shut down due to overload.

The following procedures apply when it is necessary to isolate one UPS module from the parallel system for repair due to serious malfunction:

1. Unplugging the REPO terminal deactivates the rectifier, inverter, static switch and battery, while the other UPS modules in the parallel system continue to supply the load as normal.
2. If the UPS is equipped with an external battery, simply set the corresponding external battery switch to off.
3. Set the rectifier input switch Q1, bypass input switch Q2 and output switch Q4 to off.

At this point, all the internal power supplies are deactivated and the LCD screen is switched off.

4. If the UPS is equipped with internal batteries, make sure that they have been isolated from the UPS before carrying out maintenance work on it. Refer to 6.10 .



Warning

1. Post a label on the AC input distribution line (generally at a distance from the UPS) to alert personnel that UPS maintenance is in progress.
2. Wait 10 minutes for the internal DC bus capacitors to discharge. Then the UPS is completely shut down.

7.3.4 Procedures for Inserting One UPS Module into a Parallel System



Important

These procedures may only be carried out by VERTIV service personnel, or under their supervision.

The following procedures are used to reintegrate a UPS module that has been previously isolated from the parallel system:

1. If the UPS his equipped with internal batteries, be sure to restore the connection between the UPS and internal batteries after completing maintenance work on the UPS. Refer to 6.10 for details. Next, close the rectifier input switch Q1.

At this point, the system is switched on.

2. Close the bypass input switch Q2.
3. Close the output switch Q5, and press the power button for two seconds.

7.3.5 Procedures For Completely Powering Down the UPS

In order to shut the UPS down completely and disconnect the power supply to the load, proceed as follows: All power switches, isolating switches and breakers are switched to off, and the UPS no longer supplies power to the load.



Caution

The following procedures will interrupt the power supply to the load, switching it off.

1. Unplug the REPO terminal on each UPS to deactivate the rectifier, inverter, static switch and battery.
2. If the UPS is equipped with an external battery, set the corresponding external battery switch to the off position until all the UPS modules have been disconnected from the batteries.
3. Set the rectifier input switch Q1 and bypass input switch Q2 on each UPS to off. At this point, all the internal power supplies are deactivated and the LCD screen is switched off.
4. Set the output switch Q5 on each UPS to off.
5. If the UPS his equipped with internal batteries, be sure to open the connection between the UPS and internal batteries.



Warning

1. Post a label on the AC input distribution line (generally at a distance from the UPS) to alert personnel that UPS maintenance is in progress.
2. Wait 10 minutes for the internal DC bus capacitors to discharge. Then the UPS is completely shut down.



Warning: hazardous battery voltage

Hazardous voltages are still present on the battery terminals, even after the UPS has been shut down.

7.3.6 Procedures for Shutting Down the UPS Completely While Maintaining Power to the Load

The following procedures may be used to shut the UPS down completely are applicable for completely, while maintaining the power supply to the load. Refer to the procedures in 7.3.2 .

7.4 LBS System

7.4.1 Cabinet Installation

An LBS system consists of two independent UPS systems, each consisting of two parallel UPS modules, as shown in Figure 7-3. The LBS system provides high reliability, which makes it suitable for use with loads having multiple input terminals. In the case of single-input loads, an STS may be installed to power the load.

The system uses the LBS cables to synchronise the outputs of two independent (or parallel) UPS systems. Place the UPS modules side by side and interconnect the UPS modules according to the following instructions.

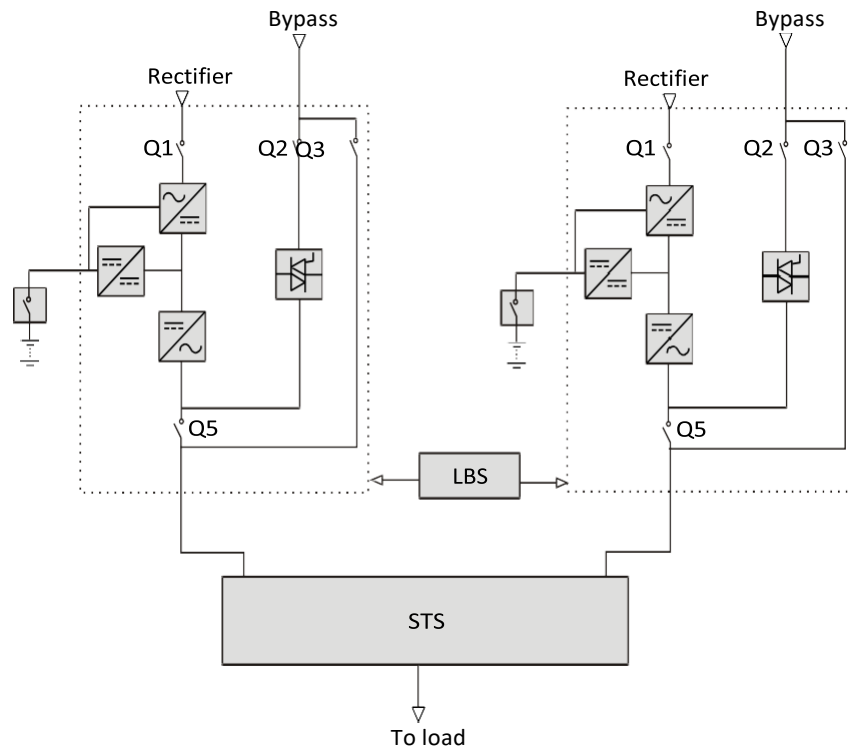

Figure 7-3 LBS system (UPS module)

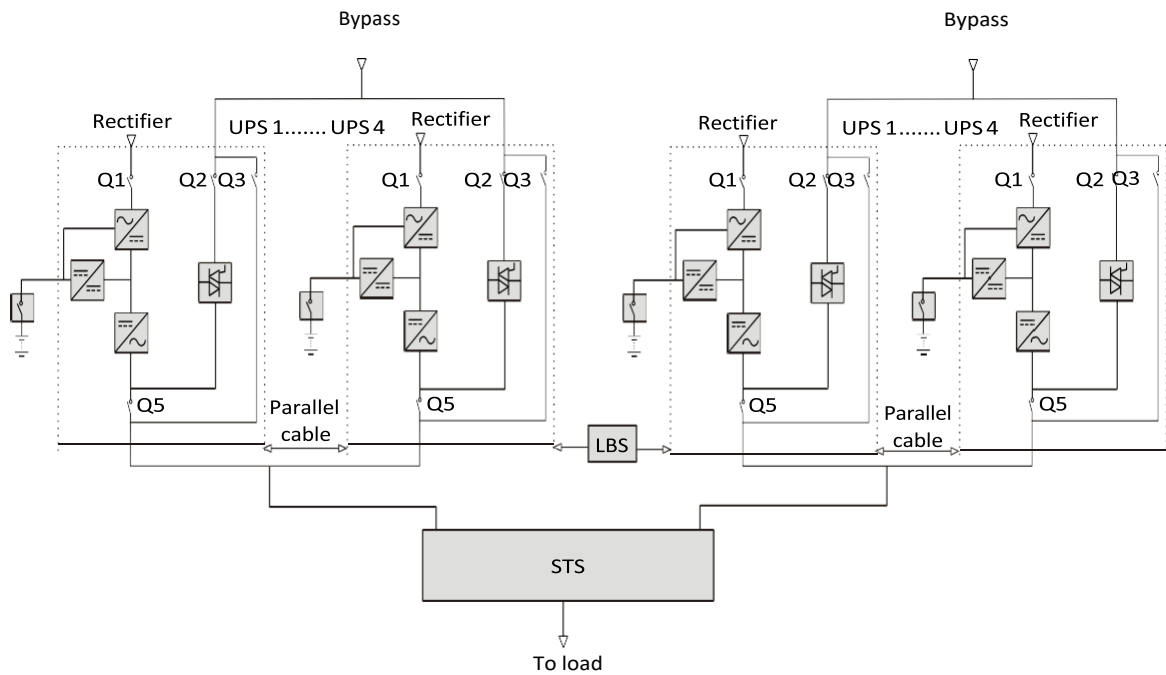



Figure 7-4 LBS system (parallel system)

	<p>Note</p> <p>In a dual-bus system, the two UPS systems must have the same power rating, voltage and frequency, and the load must not exceed the power rating of a single UPS module system.</p>
---	--

7.4.2 External Protective Device

Refer to 3.1.9 .

7.4.3 Power Cables

The power cable of dual-bus power system is similar to that of single system. Refer to 3.1 *Connecting the Power Cables*.

7.4.4 LBS Cable



Note

1. The appearance of the LBS port is the same as the parallel port (see Figure 3-6).
2. In the case of dual bus systems consisting of parallel UPS units, we recommend preparing two LBS cables for connecting any two parallel/LBS ports of the two parallel system, in order to guarantee a secure connection.

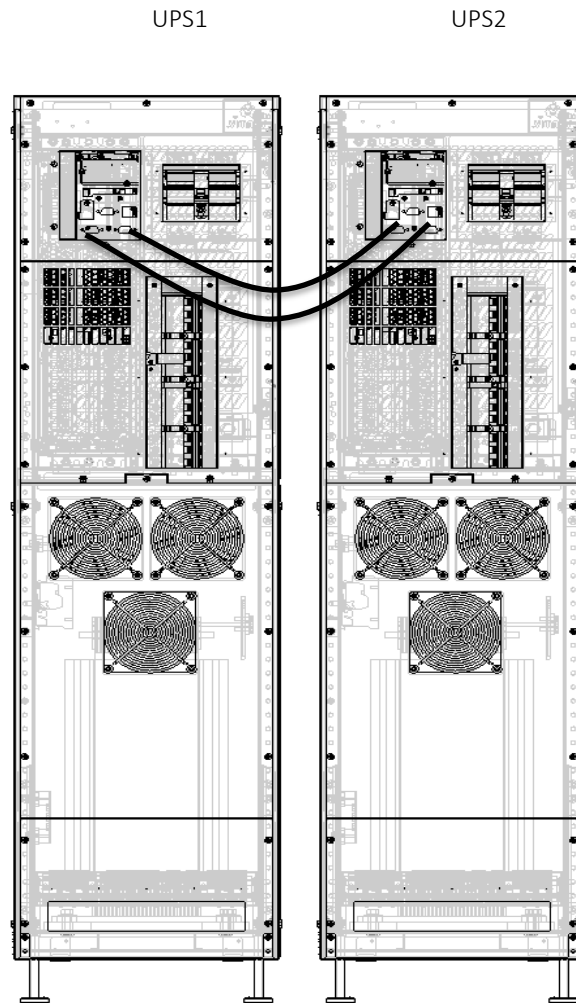

Figure 7-5 LBS cable connections

See Figure 7-6 for the LBS parameters setting interface.

LBS parameter setting procedures.

Access 'Settings' -> 'System' -> 'LBS' to set-up the LBS according to the specific requirements.

There are three items that may be selected during the LBS setting procedure: Disable, Slave, Master.

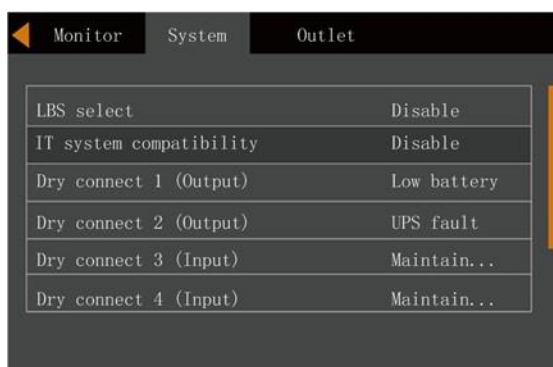

Figure 7-6 LBS parameter settings interface

The LBS is the load synchronisation system, and is used to synchronise the output voltage phases of the two sections of the UPS system. The two sections of the UPS system may consist of two single UPS units, or two UPS parallel systems.

'Master' and 'Slave' may be set-up manually via the LCD screen.

The UPS selected as the LBS master can send synchronization signals to LBS slave based on its inverter voltage phase. After the slave receives the synchronization signal sent by the master, it will adjust its inverter voltage phase so that it is synchronised with the master.

Thanks to this system, it is possible to synchronise the two sections of the UPS system, guaranteeing reliable transfer between the respective output voltages and the STS, and hence a reliable, uninterrupted power supply to the load.

Chapter 8 Options

This section lists the UPS options and provides information about installing and configuring the various options, and their respective functions.

8.1 List of Options

No.	Option name	Note	Model
1	3-in 1-out copper bar kit	Site installation	S600D
2	32-block internal battery kit (2-group)	Factory installation contains battery cables, trays and batteries; Site installation contains battery cables and trays. Battery string should be user-prepared	S600D (factory installation, 9Ah battery) S600D (site installation)
3	32-block battery internal kit (4-group)		S600D(factory installation, 9Ah battery) S600D (site installation)
4	Battery temperature sensor kit	Site installation	S600D
5	Protective devices for short circuit withstand current	Withstand current: 30kVA, factory installation	S600D
6	SIC card		UF-SNMP810
7	Relay card		UF-DRY410
8	UNITY-DP card		IS-UNITY-DP
9	UNITY-LIFE card		IS-UNITY-LIFE
10	Parallel cable	1m 3m	ITA-20k00AL3A02C00L1 ITA-20k00AL3A02CL3
11	LBS cable		ITA-20k00AL3A02C00L2
12	Backfeed protection device	Includes backfeed power board, cables, excitation tripping device; factory installation	S600D

8.2 Option Introduction



Note

1. No batteries are supplied with the internal battery kit (site installation).
2. Battery cables and battery trays are designed according to the specifications of valve-regulated lead acid batteries 12V-9Ah. If internal battery kits are required for site installation, please purchase batteries having the same specifications.

Preparation

1. Prepare the installation tools, including a cross head screwdriver, a pair of insulated gloves, a sleeve, an adjustable spanner, and a multimeter.
2. Check that all installation materials are present and complete, including internal batteries, eight battery trays and the corresponding battery power cables.

Procedures

1. Shut down the UPS completely.
 - a) Disconnect the load
 - b) Refer to 5.6.1 *Procedures For Completely Shutting Down the UPS* for UPS module shut down, and 7.3.5 for parallel system shut down.

c) All the LCDS are off, wait five minutes for the internal UPS DC bus capacitors to discharge fully.

2. Install the internal batteries.

Installing standard UPS internal batteries

a) Remove the corresponding panels, as shown in Figure 8-1. Do not throw the screws away

b) Remove the four battery accessory trays and position the batteries on them as shown in Figure 8-2, then connect

8.2 SIC Card

Figure 8-8 shows the appearance of the SIC card.

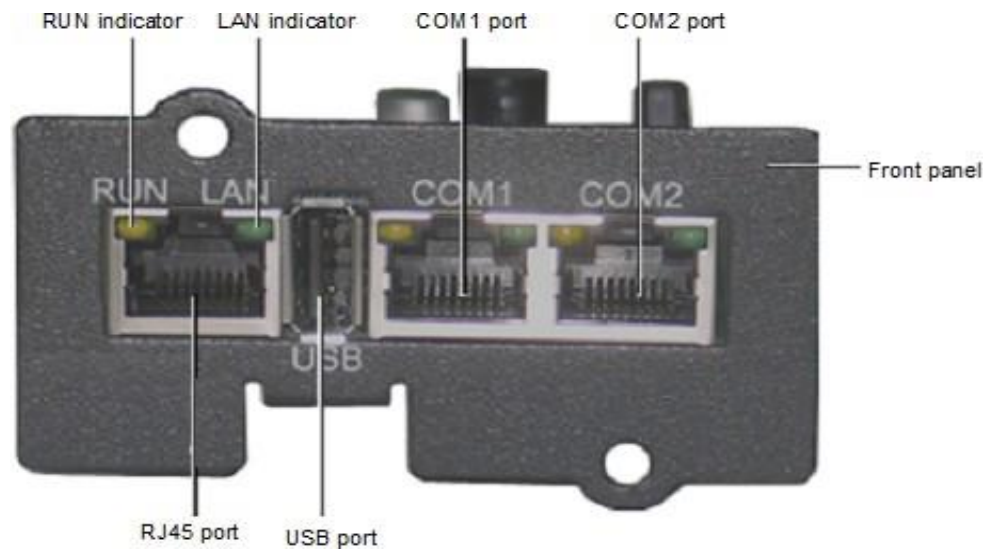

Figure 8-8 SIC card

The SIC card is a network management card. It may be used to provide network communication capability on VERTIV designed UPS modules. It can also be connected to the IRM series sensor to provide environment monitoring functions. When the intelligent device generates an alarm, the SIC card can notify the user by logging the event, sending captured information, and generating an email message.

Preparation

1. Prepare the installation tools, including a cross head screwdriver.
2. Check that all installation materials are present and complete, including an SIC card.

Procedures



Note

The SIC card is hot pluggable, therefore there is no need to shut the UPS down when installing it.



Warning

Some of the electronic components on the SIC card static sensitive, therefore, avoid touching the components or circuit on the SIC card with bare hands or other conductive materials, so as to protect the SIC card against static shock. When removing or installing the SIC card, hold the card by its edges.

The SIC card should be installed in the Intellislot port (see Figure 3-6) on the UPS.

Installation procedure:

1. Remove the cover from the Intellislot port. Keep the screws for future use.
2. Insert the SIC card (along two sides of the Intellislot port) into the port position, and then fasten the screws.

For more information about the SIC card, refer to the *bSite Interface Web/SNMP Agent Card User Manual*, which is available as an accessory.

Refer to 3.2.8 for information about wiring and routing the signal cables.

8.2.4 Relay Card

The UPS is available with a relay card that enables users to use dry contact signals to monitor the UPS. It is hot pluggable for easy installation.

The relay card can provide up to four digital relay output signals for connection to remote monitoring devices. These signals are: UPS on Battery, Battery Low, UPS on Bypass or in Standby, UPS Faulty. Each dry contact signal output channel provides both normally open and normally closed ports. The relay card can also handle up to three digital signal inputs, two of which control the UPS switch-on and switch-off functions, while the third is reserved.

Appearance and description of hardware

The appearance of the relay card is shown in Figure 8-9.

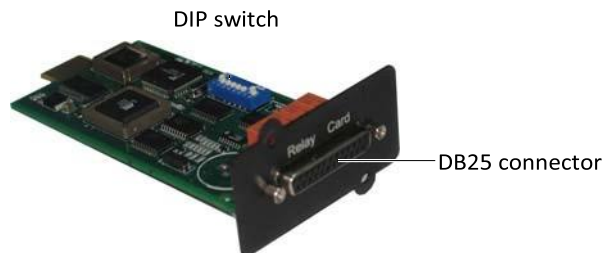

Figure 8-9 Relay card appearance

The DIP switch is used to configure the UPS switch-on and switch-off signal input functions on the relay card. The DB25 connector provides dry contact signal inputs and outputs. For a description of the DB25 connector pins, see Table 8-3.

Table 8-3 DB25 connector pin description

Pin No.	Pin name	Description	
Pin 1	Va, power output	9 - 15Vdc (reserved for factory use)	
Pin 14	K0_NO, Channel 0 dry contact normally open output contact	Closed: UPS on Battery	Electrical parameter: 30Vdc/1.8A, resistive load
Pin 2	K0_COM, Channel 0 dry contact common output contact		
Pin 15	K0_NC, Channel 0 dry contact normally closed output contact	Open: UPS on battery	
Pin 3	K1_NO, Channel 1 dry contact normally open output contact	Closed: Battery Low	
Pin 16	K1_COM, Channel 1 dry contact common output contact		
Pin 4	K1_NC, Channel 1 dry contact normally closed output contact	Open: Battery Low	
Pin 17	K2_NO, Channel 2 dry contact normally open output contact	Closed: UPS on Bypass or in Standby	
Pin 5	K2_COM, Channel 2 dry contact common output contact		
Pin 18	K2_NC, Channel 2 dry contact normally closed output contact	Open: UPS on Bypass or in Standby	
Pin 6	K3_NO, Channel 3 dry contact normally open output contact	Closed: UPS Fault	
Pin 19	K3_COM, Channel 3 dry contact common output contact		
Pin 7	K3_NC, Channel 3 dry contact normally closed output contact	Open: UPS Fault	
Pin 24	DRY_IN2, Channel 2 dry contact signal input	Reserved	
Pin 12	DRY_IN1, Channel 1 dry contact signal input	The UPS is switched off if this contact is closed for more than one second	
Pin 25	DRY_IN0, Channel 0 dry contact signal input	The UPS is switched on if this contact is closed for more than one second	
Pin 9	RXD_PC, for communication to PC, receive terminal	Reserved, for factory commissioning	
Pin 21	TXD_PC, for communication to PC, send terminal	Reserved, for factory commissioning	
Pin 13	GND, common GND	Power GND, dry contact signal input common GND	
Others	NC		

Cable options

VERTIV provides three cable options for connections to the DB25 connector of the relay card, depending on the user's requirements

Figure 8-10 - Figure 8-12 show the appearance and wiring principle of each cable.

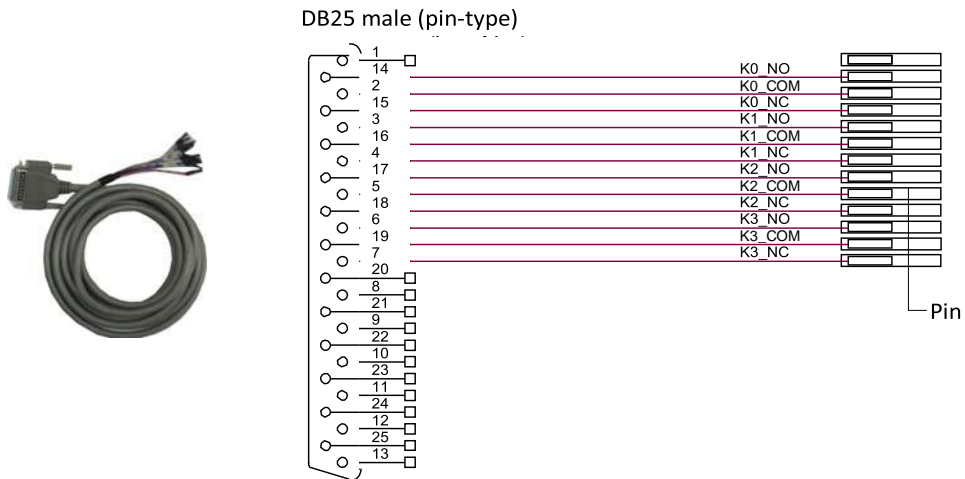

Figure 8-10 Appearance and wiring diagram of cable 1 (UFDY21SL1)

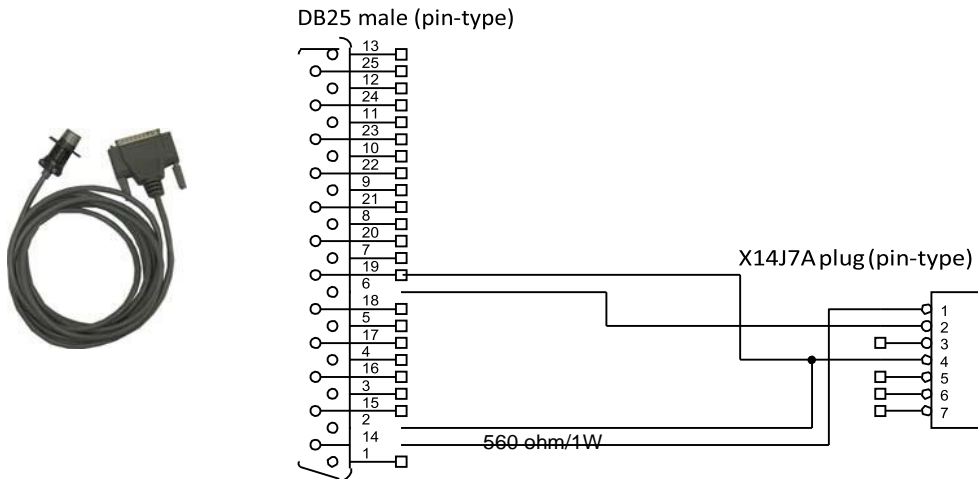

Figure 8-11 Appearance and wiring diagram of cable 2 (UFDRY21SL2)

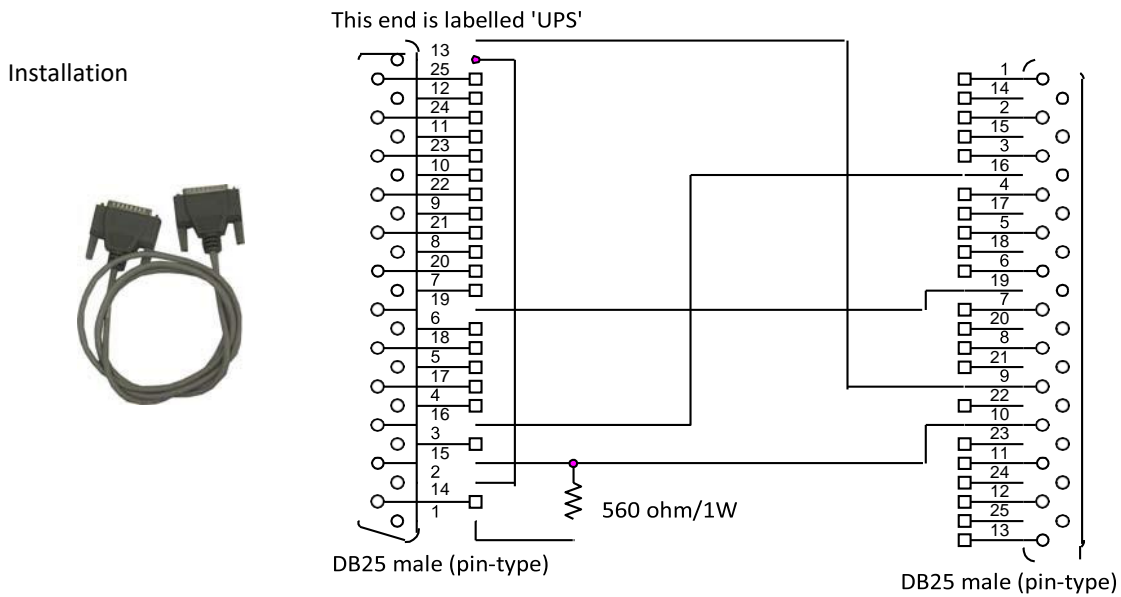

Figure 8-12 Appearance and wiring diagram of cable 3 (UFDRY21SL3)

Note

Some electronic components on the relay card are sensitive to static electricity. To prevent static electricity from damaging the relay card, do not touch its electronic components or circuits, also make sure that they do not come into contact with live parts. Please hold the relay card by its edges when handling or installing it.

1. Set the DIP switch on the relay card.

Skip this step if you do not need to control the UPS switch-on and switch-off functions via the relay card.

The location of the DIP switch is shown in Figure 8-13. It is an 8-bit DIP switch. Its factory default setting is shown in Figure 8-6.

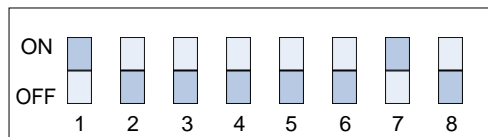

Figure 8-13 DIP switch factory default setting

Bits 1 through 7 are designed for use in the factory, the user is not permitted to change their default settings. Bit 8 is used to configure the UPS switch-on and switch-off signal input function on the relay card, see Table 8-4 for instructions on how to set it.

Table 8-4 Setting the UPS switch-on and switch-off signal input function

Bit 8	Function
ON	UPS switch-on and switch-off signal input function enabled
OFF	UPS switch-on and switch-off signal input function disabled

2. Insert the relay card into the UPS.



Note

The relay card is hot-pluggable, therefore it may be installed without shutting the UPS down.

- a) Remove the Intellislot port cover (see Figure 3-6) on the front panel. Do not throw the screws away.
 - b) Align the relay card with the Intellislot port, insert the relay card into the port along the grooves on both sides of the port.
 - c) Secure the relay card in place through the fixing holes on the relay card panel using the screws from step a).
3. Connect the cable.

You can select an optional cable according to your needs, or prepare your own, in accordance with Table 8-4 and Figure 8-10 - Figure 8-12. Connect the cable end with the DB25 male connector to the DB25 connector of the relay card, and the other end to the user equipment.



Warning

The DB25 connector must be connected to a SELV circuit. Failure to observe this could damage the relay card and even lead to accidents.

Troubleshooting

See Table 8-5 for relay card troubleshooting information.

Table 8-5 Troubleshooting

No.	Problems	Corrective measures
1	The dry contact output signal remains the same when the UPS status changes	Check that the relay card has been inserted into the Intellislot port correctly
2	The UPS does not respond to the UPS switch-on dry contact input signal	Verify that bit 8 of the DIP switch of the relay card has been set to the 'ON' position

The relay card installation method is the same as for the SIC card, as described in 8.2.3 . Refer to 3.2.8 for information about wiring and routing the signal cables.

8.2.5 IS-UNITY-DP Card



Important

We recommend using shielded cables in order to increase EMC.

The appearance of IS-UNITY-DP card is shown in Figure 8-14.



Figure 8-14 IS-UNITY-DP card

For a detailed description of the IS-UNITY-DP card, refer to *Liebert IntelliSlot Unity Card User Manual–Web, SNMP, Modbus, BACnet, YDN23*, which is available as an accessory.

8.2.6 IS-UNITY-LIFE Card



Important

We recommend using shielded cables in order to increase EMC.

The appearance of the IS-UNITY-LIFE card is shown in Figure 8-15.



Figure 8-15 Appearance of IS-UNITY-LIFE card

For a detailed description of the IS-UNITY-LIFE card, refer to *Liebert IntelliSlot™ Unity Card User Manual–Web, SNMP, Modbus, BACnet, YDN23*, which is available as an accessory.

Use the following procedures to switch the UPS on when it is in the fully switched off state.

1. Ensure that the internal maintenance bypass switch Q3 is off, and that the input cables and copper bars are connected securely. Ensure that the input cables and copper bars are connected securely according to the 3-in 1-out power distribution mode configuration.



Warning

To avoid generating spurious fault messages, whenever it is necessary to switch the maintenance bypass switch to the on or off position, the operation must be completed within three seconds.

2. Before switching the system on, use a multimeter to measure the voltage on the rectifier terminals (mA-mB-mC), and make sure that there are no circuits; if so, check that the connections are correct.
3. Unplug the REPO terminal at rear of the cabinet, and then close the rectifier input switch Q1, at this point the system is switched on.
4. Press , and access -> Settings (default password is '111111') -> Output -> Output phase No., then set the system to '1 phase'. After the system is switched off, switch it on again, access this menu once more and confirm that this setting has been applied.

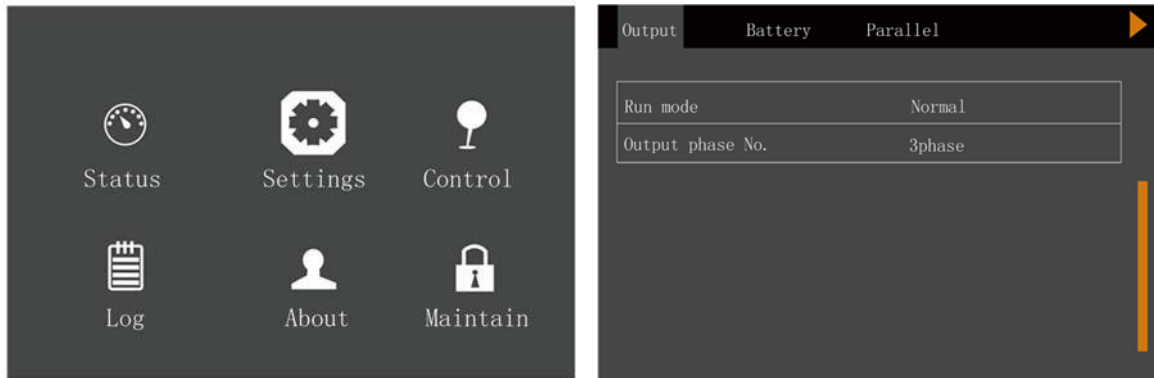

Figure 8-20 Prompt window

5. Set the rectifier input switch Q1 to the off position to shut the UPS down completely.
6. Plug-in the REPO terminal, close the UPS bypass input switch Q2 and the rectifier input switch Q1 in that order. At this point, the system is switched on.
7. After the rectifier starts, close the output switch Q5 and all the external output isolation switches (if any).
8. Press the power button for two seconds to start the inverter.

8.2.8 Protective Devices For Short Circuit Withstand Current

This kit contains three bypass fuses (one fuse for each phase) designed to guarantee the UPS withstand short circuit at 30kVA. If this kit is installed, please refer to Figure 8-21 for the fuse blow-out curve when choosing the UPS downstream switch and transformer load.

Time-Current Curve

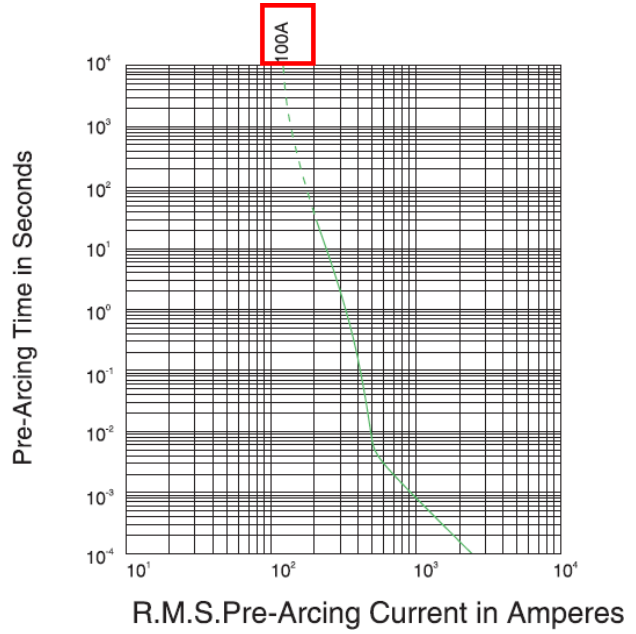
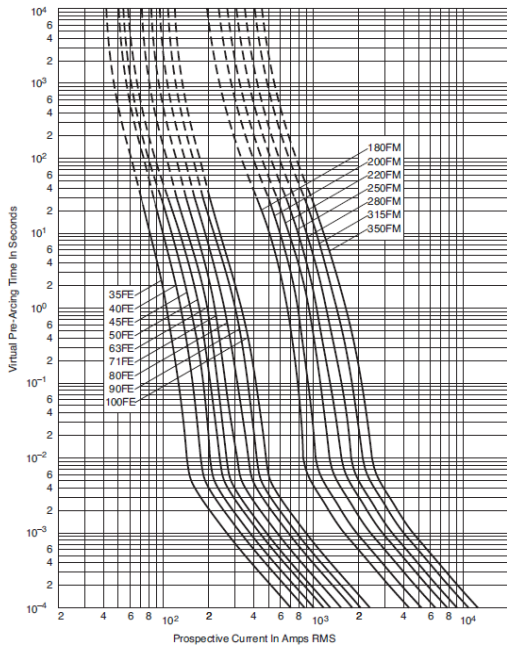

Manufacturer: Bussmann, model: 100FE

Manufacturer: Vicfuse, model: VBS1749-100A

Figure 8-21 Schematic diagram of fuse blow-out

Chapter 9 Service And Maintenance

This section focuses on UPS maintenance, including fan maintenance, battery maintenance, UPS cleaning, UPS state checks, and UPS function checks.



Note

Never attempt to carry out maintenance on the UPS while it is on line. Ensure that the UPS has been switched off completely when performing any internal maintenance operations on it.

9.1 Fan Maintenance



Note

In order to avoid injury or damaging the device, wait until the fan is completely stationary before inserting fingers or any tools into it.

The UPS fans are expected to run for 20,000 hours - 40,000 hours in continuous operation. The higher the ambient temperature, the shorter the fan life.

During the UPS operation, it is important to check the condition of the fans at least once a year by confirming that they blow air out of the ventilation holes on the rear panel.

9.2 Battery Maintenance



Warning

1. Never invert the battery connections as this could result in fires.
2. Never attempt to open batteries since they contain electrolyte which is potentially harmful to personnel. In the event of accidental with electrolyte, wash the affected area with abundant, clean water, and seek medical assistance immediately.

The internal UPS battery module houses a sealed, lead-acid, maintenance-free battery. The battery life depends on the ambient temperature, and charge and discharge times. High ambient temperatures and heavy discharge cycles will shorten the battery life.

To preserve the battery life, it is necessary to:

Maintain the ambient temperature between 15°C and 25°C

Prevent small current discharge. DO NOT operate the UPS in battery mode for periods in excess of 24 hours.

Charge the battery for at least 12 hours if it hasn't been charged for three months while the ambient temperature remains within the specified limits, or two months in the event of high ambient temperatures



Note

1. Check the battery connection screws at regular intervals, and re-tighten them if necessary.
2. Make sure that all the safety devices are present, in good condition and that they function correctly, and make sure that the battery management parameter settings are correct.
3. Measure and log the ambient temperature in the battery room.
4. Check whether the battery terminals are damaged or hot, and check the condition of the cases and the covers.

If any of the batteries are found to be leaking, place them in a suitable container and dispose of them in accordance with local regulations.

Lead-acid batteries are classified as hazardous waste material. The control of waste battery pollution is a nationally important issue. Batteries must be stored, transported, used and disposed of in accordance with national and local legal requirements and all other criteria applicable to the treatment of hazardous waste material and waste battery pollution prevention.

According to the applicable regulations, waste lead-acid batteries must be recycled, while all other disposal methods are prohibited. Uncontrolled or random disposal of waste lead-acid batteries, or other improper disposal methods can result in serious environmental pollution, which will be investigated by the relevant authorities.

As a provider of lead-acid batteries, VERTIV has developed a dedicated service network and waste battery recycling system to assist users to dispose of waste batteries legally. Contact VERTIV or your nearest service centre for detailed information about the waste battery the recycling system.

VERTIV may not be held liable for the environmental impact resulting from the failure to comply with the guidelines set out in this section, or to use the waste battery recycling system offered by VERTIV.

9.3 Cleaning the UPS

Clean the UPS periodically, especially the ventilation holes, to ensure free airflow inside the UPS. If necessary, clean the UPS with a vacuum cleaner. Confirm that the ventilation holes are unobstructed.

9.4 Checking the UPS Status

We recommend checking the operational state of the UPS at least twice a year.

Check the following items:

1. Check for any UPS fault conditions: Is the FAULT indicator on? Are there any UPS alarms active?
2. Check if the UPS is operating in Bypass mode. Under normal conditions, the UPS operates in Normal mode; if you find that it is operating in Bypass mode, determine the reason (operator intervention, overload, internal fault, etc.)
3. Check if the battery is discharging: When the AC mains supply is within normal limits, the battery should not be discharging; if you find that it is operating in Bypass mode, determine the reason (mains failure, battery test, operator intervention, etc.)

9.5 Checking the UPS Functions



Note

Checking the UPS functions may interrupt the power supply to the load!

We recommend checking the UPS functions at least twice a year.

Backup the load data before conducting the UPS functional check. The procedures are as follows:

1. Press the power button to check if the buzzer beeps, the indicators are on and the LCD display is normal.
2. Press the power key and check again that the indicators are on, the LCD display is normal, and that the UPS has been transferred to inverter mode.

Chapter 10 Specifications

This section lists the UPS specifications.

10.1 Conformity and standards

The UPS has been designed to comply with the European and international standards listed in Table 10-1.

Table 10-1 European and international standards

Item	Reference Standards
General safety requirements for UPS	IEC/EN62040-1+A1:2013/AS62040-1
EMC requirements for UPS	IEC/EN62040-2:2006/AS62040-2
Method of specifying the performance and test requirements of UPS	IEC/EN62040-3/AS62040-3 (VFI SS 111)



Note

The product standards in this table incorporate relevant compliance clauses with generic IEC and EN standards for safety (IEC/EN/AS60950), electromagnetic emission and immunity (IEC/EN/AS61000 series) and construction (IEC/EN/AS60146 series and 60529).

10.2 Environmental Characteristics

Table 10-2 Environmental characteristics

Item	Unit	Rated power (kVA)
		10kVA-20kVA
Noise at 1m (measured frontally)	dB (A)	58
Altitude	m	≤ 3000
Relative humidity	%RH	0 - 95%, non condensing
Operating temperature	°C	0 - 40°C (Note: Battery life is halved for every increase of 10°C above 20°C)
UPS storage temperature	°C	-25°C - +55°C
UPS shipping temperature	°C	-40°C - +70°C

10.3 Mechanical Specifications

Table 10-3 Mechanical specifications

Item	Unit	Rated power (10kVA-20kVA)
		Standard UPS
Dimensions (W × D × H)	mm	335x650x1300
Net weight	kg	340(Approx)
Gross weight	kg	350(Approx)
Colour	kg	RAL7021
Protection rating, IEC (60529)	kg	IP20

10.4 Electrical Specifications (Input Rectifier)

Table 10-4 Rectifier AC input (mains)

Item	Unit	Rated power (kVA)
		10kVA-20kVA
Rated AC input voltage ¹	Vac	380/400/415, 3-phase 4-wire (+PE) TN/TT power distribution system
Input voltage range ²	Vac	305 - 499
Frequency ²	Hz	50/60 (range: 40 - 70)
Power factor	kW/kVA, full load (half load)	0.96 (0.95)
Total current harmonic distortion	%	Linear full load < 3% (battery float charge) (3-in 1-out) Non-linear full load < 5% (battery float charge) (3-in 1-out) Linear half load < 7% (battery float charge) (3-in 1-out) Non-linear half load < 8% (battery float charge) (3-in 1-out)



Note

1. The rectifiers will operate at any of the rated supply voltages and frequencies without the need for any further adjustment.
2. At 305V input mains, the UPS maintains the specified output voltage at rated load without discharging the battery.

10.5 Electrical Specifications (Intermediate DC Circuit)

Table 10-5 Battery

Item	Unit	Rated power (kVA)
		10kVA-20kVA
Quantity of lead-acid batteries ¹	Block	12,16,20 / 24, 32, 40 (12Vdc)
Float voltage	V/cell (VRLA)	2.27 (selectable from 2.2V/cell to 2.3V/cell) Constant current and constant voltage charge mode
Temperature compensation	mV/°C/cell	-3.0 (selectable from 0 to -5.0 around 25°C or 30°C, or inhibit)
Ripple voltage (float charge)	%	≤ 3%
Boost voltage	V/cell (VRLA)	2.35 (selectable from 2.3 to 2.4) Constant current and constant voltage charge mode
Boost control		Float-boost current trigger 0.05C ₁₀ (selectable from 0.02 to 0.08) Boost-float current trigger 0.02C ₁₀ (selectable from 0.01 to 0.05) 12h safety time time-out (selectable from 5h to 24h) Boost mode inhibit also selectable
EOD voltage	V/cell (VRLA)	1.60 - 1.85
Battery charger	V/cell	02:35 Constant current and constant voltage charge mode; Boost charge mode automatic trigger or boost charge mode inhibit also selectable



Note

1. When the number of battery is 24-block, the maximum output capacity of the UPS is 70% of rated capacity.

10.6 Electrical Specifications (Inverter Output)

Table 10-6 Inverter output (to critical load)

Item	Unit	Rated power (kVA)
		10kVA-20kVA
Rated AC voltage ¹	Vac	220/230 (1-phase 2-wire, with neutral reference to the bypass neutral) (3-in 1-out)
Frequency ²	Hz	50/60
Overload	%	For linear load requirements: < 105%, continuous; 105 - 125% of rated load, 5min; 125 - 150% of rated load, 1min; > 150%, 200ms
Non-linear load capacity ³	%	100%
Steady state voltage stability	%	±1% for balanced three phase load; ±2% for unbalanced load
Transient voltage response ⁴	%	±5% for 100% rated linear load step
Total harmonic voltage	%	2% (100% linear load); 5% (100% non-linear load)
Synchronisation window	Hz	Rated frequency ±0.5, ±1, ±2, ±3 (settable)
Slew rate (max. change rate of synchronisation frequency)	Hz/s	Setting range: 0.2, 0.5, 1 (UPS module), 0.2 (parallel system)



Note

1. Factory set to 220V. 230V or 240V can be selected by service engineer at site.
2. Factory set to 50Hz. 60Hz can be selected by service engineer at site. Note that the system frequency may only be changed when the UPS is in bypass mode. It is strictly prohibited to change the system frequency when the UPS supplying the load via the inverter.
3. EN 50091-3 (1.4.58) crest factor 3:1, non-linear load.
4. IEC/EN 62040-3/EN 50091-3 also for 0 - 100% - 0 load transient. Transient recovery time: returns to within 5% of steady state output voltage within half a cycle.

10.7 Electrical Specifications (Bypass Input)

Table 10-7 Bypass input

Item	Unit	Rated power (kVA)
		10kVA-20kVA
Rated AC voltage ¹	Vac	220/230/240, 1-phase 2-wire, sharing neutral with the rectifier input and providing neutral reference for the output, (3-in 1-out)
Overload	%	Based on nominal voltage and rated load current under apparent power: < 105%, continues; 105 - 125% of rated load, 10min; 125 - 150% of rated load, 1min; > 150%, 200ms
Frequency ²	Hz	50/60
Bypass voltage tolerance	%Vac	Upper limit: +10%, +15% or +20%, default: +20%; Lower limit: -10%, -20%, -30% or -40%, default: -40%
Bypass frequency tolerance	%	±5% or ±10%, default: ±10%
Synchronisation window	Hz	Rated frequency ±0.5, ±1, ±2, ±3, ±4, ±5 (settable); ±5 by default



Note

1. Factory set to 220V. 230V or V can be selected by service engineer at site.
2. Factory set to 50Hz. 60Hz can be selected by service engineer at site.

Appendix 1 LCD Parameter Settings

Menu	Item	Setting range	Default setting	
System	Auto restart	Disable, Enable	Enable	
	Auto restart delay	0~999 seconds	10; Single unit only	
	Guaranteed shut-down	Disable, Enable	Disable	
	Remote control	Disable, Enable	Enable	
	Remote power on delay	0~999 seconds	0	
	Remote shut-down delay	0~999 seconds	0	
	Redundant	NO, YES	YES	
	LBS select	Disable, Master, Slave	Disable;/20 KVA Only	
	IT system compatibility	Disable, Enable	Disable	
	Dry contact 1 (Output)	Low battery, On bypass, On battery, UPS fault	Low battery	
	Dry contact 2 (Output)	Low battery, On bypass, On battery, UPS fault	UPS fault	
	Dry contact 3 (Input)	Battery mode shut-down, Any mode shut-down, Maintain mode	Maintain mode	
	Dry contact 4 (Input)	Battery mode shut-down, Any mode shut-down, Maintain mode	Maintain mode	
Output	Voltage selection	220V, 230V, 240V	220V	
	Start-up on bypass	Disable, Enable	Disable	
	Frequency selection	Auto, BypEna; Auto, BypDisa; 50Hz, BypDisa; 60Hz, BypDisa	Auto, BypEna	
	Inverter sync range	±0.5Hz, ±1.0Hz, ±2.0Hz, ±3.0Hz, ±4.0Hz, ±5.0Hz	±3.0Hz	
	Bypass voltage upper limit	+10%, +15%, +20%	+20%	
	Bypass voltage lower limit	-10%, -20%, -30%, -40%	-40%	
	Bypass frequency range	±5Hz, ±10Hz	±10Hz	
	Run mode	Normal, ECO mode	Normal	
	ECO voltage range	±5%, ±10%, ±15%	±10%	
	ECO frequency range	±1Hz, ±2Hz, ±3Hz	±3Hz	
	ECO requalification time	5, 15, 30 (min)	30	Appear only when the 'Run mode' is set to 'ECO mode'
	Output phase No.	1 phase, 3 phases	3	
Parallel	Voltage selection	220V, 230V, 240V	220V	
	Frequency selection	Auto, BypEna; Auto, BypDisa; 50Hz, BypDisa; 60Hz, BypDisa	Auto, BypEna	
	Run mode	Normal, ECO mode	Normal	
	Redundant	NO, YES	YES	
	System parallel No.	1~4	1	
	Output phase No.	1 phase, 3 phases	3 phases/20 KVA Only	
	Sync parallel parameters	Button	Button	
Battery	Shared battery	Enable, Disable	Disable;/20 KVA Only	
	Local/Parallel battery total Ah	7~3000Ah	9Ah-10KVA 18Ah-20KVA	
	External battery cabinet count	Auto test, 0~10	Auto test	
	Low battery time	2~30 (min)	2	
	Battery replaced time	YYYY-MM-DD HH:MM:SS	2000-01-01 0:00:00	
	Battery test interval	Disable, 8 weeks, 12 weeks, 16 weeks, 20 weeks, 26 weeks	Disable	

Menu	Item	Setting range	Default setting
	Battery test weekday	Sunday, Monday, Tuesday, Wednesday, Thursday, Friday, Saturday	Wednesday
	Battery test time	HH:MM:SS	0:00:00
	Battery series	10KVA-12,16,20 20KVA-24, 32, 40	16(10KVA) 32(20KVA)
	Discharge protect time	1~4320 (min)	4320
	Equal charge enable	YES, NO	NO
	Temperature compensation	Enable, Disable	Disable
	Replace battery	Button	Button
Outlet	Turn on outlet		Appear only when outlet off
	Turn off outlet		Appear only when outlet on
	Reboot outlet		Appear only when outlet on
	Turn off when UPS overload on battery	YES, NO	NO
	Turn off when UPS on battery for	0~4320 (min)	2
	Turn off when backup time less than	0~4320 (min)	0
	Turn off when battery capacity less than	20~80%	30%
	Turn on when power returns for	0~4320 (min)	0
Monitor	Language	English, Chinese	English
	Date	YYYY-MM-DD	2016-10-01
	Time	HH:MM:SS	00:00:00
	Display orientation	Auto-rotate, Horizontal, Vertical	Auto-rotate
	Audible alarm	Enable, Disable	Enable
	Control port protocol	Modbus, Sensor	Sensor
	Modbus address	1~128	1
	IPv4 address	ddd.ddd.ddd.ddd (where 'd' is a decimal number)	192.168.1.10
	Subnet mask		255.255.255.0
	Gateway address		192.168.1.1
	Change settings password	The password may be a numerical value only and include any character between 0 and 9. The password length is 6 characters	111111

Appendix 2 Glossary

AC	Alternating current
BCB	Battery circuit breaker
CSA	Cross sectional area
DC	Direct current
EIB	External interface board
EMC	Electromagnetic compatibility
EMI	Electromagnetic interference
EOD	End-of-discharge
EPO	Emergency power off
I/O	Input/output
IGBT	Integrated gate bipolar transistor
LBS	Load bus synchronizer
LCD	Liquid crystal display
LED	Light-emitting diode
PC	Personal computer
PE	Protective earth
RCCB	Residual current circuit breaker
RCD	Residual current detector
SCR	Silicon-controlled rectifier
SNMP	Simple network monitoring protocol
STS	Static transfer switch
SVPWM	Space vector pulse width modulation
UPS	Uninterruptible power system
VRLA	Valve-regulated lead-acid

Appendix 3 Hazardous Substances And Content

Parts	Hazardous substances					
	Lead	Mercury	Cadmium	Chrome ⁶⁺	PBB	PBDE
	(Pb)	(Hg)	(Cd)	(Cr (VI))	(PBB)	(PBDE)
Hex copper stud	x	o	o	o	o	o
PCBA	x	o	o	o	o	o
AC capacitor	x	o	o	o	o	o
DC capacitor	x	o	o	o	o	o
Fan	x	o	o	o	o	o
Cables	x	o	o	o	o	o
LCD	x	x	o	o	o	o
Sensors	x	o	o	o	o	o
Large-medium power magnetic components	x	o	o	o	o	o
Circuit breaker/rotating switch	x	o	o	o	o	o
Semiconductors	x	o	o	o	o	o
Battery (when applicable)	x	o	o	o	o	o
Insulation monitoring device (when applicable)	x	o	o	o	o	x
<p>This table has been prepared in accordance with the Standard SJ/T 11364.</p> <p>o : Indicates that the content of hazardous substances in the average quality of all the materials used to manufacture the parts is within the limits specified in GB/T 26572</p> <p>x: Indicates that the content of hazardous substances in the average quality of at least one of the materials used to manufacture the parts is outside the limits specified in GB/T 26572</p> <p>About the battery: In general adhere to the environmental protection usage period of the battery, otherwise five years.</p> <p>Limit of applicability S700 10kVA-20kVA UPS</p>						

